



# FRANKLIN TRANSPORTATION & STREET TECHNICAL STANDARDS

EFFECTIVE  
JULY 1, 2024



HISTORIC  
FRANKLIN  
TENNESSEE



# City of Franklin, TN Transportation & Street Technical Standards, 2024 Edition

Chapter	Chapter Title	Pg.
1	General Provisions and Requirements	1-1
2	Street Design	2-1
3	Drainage Design	3-1
4	Earthwork and Demolition	4-1
5	Pavement Design	5-1
6	Concrete	6-1
7	Structures	7-1
8	Signal Design	8-1
9	Street Lights	9-1
10	Traffic Signs and Markings	10-1
	Glossary	

**CHAPTER**  
**1**

# GENERAL PROVISIONS AND REQUIREMENTS

Section	Section Title	Article	Article Title	Pg
1.1	Title			1-2
1.2	Purpose			1-2
1.3	Authority			1-3
1.4	Applicability			1-2
1.5	Compatibility			1-2
1.6	City Engineer			1-2
1.7	Standard Drawings and Typical Street Sections			1-3
1.8	Specifications and Resources			1-3
1.9	Plan Standards			1-4
		1.9.1	Survey	1-4
		1.9.2	Construction Plan Submittal	1-4
		1.9.3	Revision of Plans	1-7
1.10	Plan Review Procedure /Fees	1.10.1	Submittal Requirements and Fees	1-7
		1.10.2	Approval of Drawings and Fees	1-7
		1.10.3	Expiration of Construction Drawings	1-7
1.11	Utility Coordination			1-7
1.12	Historical Research Resources			1-8
1.13	Permits			1-8
1.14	Notification of Construction			1-8
1.15	Quality Control Testing			1-8
1.16	Inspection			1-9
1.17	As-Built Plan Submittal			1-9
1.18	Acceptance of Facilities			1-10
1.19	Existing Streets			1-10
1.20	Modifications of Engineering Standards			1-10
1.21	Appeal of City Engineer Order or Decision			1-11
1.22	Revisions to these Standards			1-11

### **1.1 Title**

These standards shall be known as the “Franklin Transportation and Street Technical Standards”, referred to throughout this document as “these Standards.”

---

### **1.2 Purpose**

The purpose of these Standards is to provide reasonable design and construction guidelines for transportation infrastructure within the City of Franklin that promote economical and durable designs and allow for safe and efficient traffic movement.

---

### **1.3 Authority**

These Standards were adopted by the Board of Mayor and Aldermen (BOMA) on June 28, 2022 by Ordinance 2022-15 and became effective on July 1, 2022.

Administrative changes and minor revisions to these Standards as approved by the City Engineer per Franklin Municipal Code Chapter 11, Title 16, Section 16-1101 became effective July 1, 2024.

---

### **1.4 Applicability**

Except as may otherwise be required by law, these rules and regulations govern the construction of new streets, existing streets requiring improvement or rehabilitation, and all associated improvements and appurtenances, both public and private, installed in the City of Franklin, Tennessee (“the City”).

---

### **1.5 Compatibility**

If any provision of these Standards and any other provisions of law impose overlapping or contradictory requirements, or contain any restrictions covering any of the same subject matter, that provision which is more restrictive or imposes higher standards or requirements shall govern unless otherwise specified.

These Standards do not relieve the applicant from provisions of any other applicable code, ordinance, or regulation.

Any conflicts, errors, or omissions in the approval of any application shall not relieve the applicant from compliance with these Standards, or with any other regulatory agency with jurisdiction over the project.

---

### **1.6 City Engineer**

All places within these Standards that reference the “City Engineer” shall refer to the City of Franklin, Tennessee City Engineer or their designated representative.

---

## 1.7 Standard Drawings and Typical Street Sections

The Standard Drawings and Typical Street Sections produced by the City of Franklin Engineering Department and available online on the City of Franklin Engineering webpage are incorporated by reference into these Standards.

---

## 1.8 Specifications and Resources

Infrastructure within the City shall be designed and constructed per the latest edition of the following documents:

- "A Policy on Geometric Design of Highways and Streets", latest edition, American Association of State Highway and Transportation Officials; AASHTO. (Hereinafter referred to as the "Green Book").
- "Guidelines for Geometric Design of Very Low-Volume Local Roads ( $ADT \leq 400$ )", latest edition, American Association of State Highway and Transportation Officials; AASHTO.
- "Guide for the Development of Bicycle Facilities", latest edition, American Association of State Highway and Transportation Officials; AASHTO.
- "AASHTO Roadside Design Guide", latest edition, American Association of State Highway and Transportation Officials; AASHTO.
- "Traffic Engineering Handbook", latest edition, Institute of Transportation Engineers
- "Trip Generation Manual", latest edition, Institute of Transportation Engineers.
- "Manual on Uniform Traffic Control Devices for Streets and Highways", latest edition, U.S. Department of Transportation, Federal Highway Administration; FHWA. (Hereinafter referred to as the "MUTCD").
- "Roundabouts: An Informational Guide", latest edition, U.S. Department of Transportation, Federal Highway Administration; FHWA.
- "Public Right of Way Accessibility Guidelines" latest edition, United States Access Board. (Hereinafter referred to as the "PROWAG").
- "AASHTO LRFD Bridge Design Specifications", latest edition, American Association of State Highway and Transportation Officials; AASHTO.
- "Recommended Practice for Design and Maintenance of Roadway and Parking Facility Lighting, ANSI/IES RP-8", latest edition, American National Standards Institute, ANSI, and Illuminating Engineering Society, IES.
- The following Publications of the Tennessee Department of Transportation, latest editions. (Hereinafter referred to as "TDOT Standard Specifications")
  - "TDOT Standard Specifications for Road and Bridge Construction"
  - "TDOT Survey Manual"
  - "TDOT Roadway Design Guidelines"
  - "TDOT Standard Drawings"
  - "TDOT Traffic Design Manual"



- The City of Franklin Supplemental Specifications To: The Tennessee Department of Transportation Specifications for Road and Bridge Construction, March 1, 2015 as amended.
- The City of Franklin Corridor and Connector Streets Economic Development Projects; Zoning Ordinance; Stormwater Ordinance; Subdivision Regulations; Major Thoroughfare Plan; Land Use Plan, and Administrative Manual, latest editions.

In the case of a conflict between the documents above and provisions elsewhere in these Standards, the provisions in these Standards shall govern, unless the construction is within State of Tennessee right-of-way.

---

## 1.9 Plan Standards

In order to provide consistency and maintain accuracies, the following criteria are to be adopted for the roadway plans.

Plans submitted must be submitted in PDF and AutoCAD format. Each plan submittal shall be completed digitally through the City's Electronic Plan Submittal Process.

Exemptions to these standards may be granted by the City Engineer upon request, based on project scope and location.

### 1.9.1 Survey

Survey information in the form of point data files must be included at the time of plan submission. All survey data gathering shall adhere to "TDOT Standard Specifications".

Survey procedures require that all surveys shall be tied to the State Plane Coordinate System using the Tennessee Geodetic Reference Network (TGRN). All surveyed coordinate values will be based on the North American Datum 1983 (NAD/83) (1995 adjustment) coordinates and appropriate notes indicating such shall appear on the topography plot.

All design computations shall be based on these adjusted coordinate values. This will ensure that all computed points on the project will have coordinate values tied to the State Plane System. Assumed coordinates will not be used.

Coordinate values for all PI's shall be shown on present and proposed (if any are shown) layout sheets within each curve data table. Coordinate values shall also be listed for the beginning and ending points of the project. A notation near the title block in lower right hand corner for each sheet on which coordinates appear shall read, "Coordinates are NAD/83 (1995), are datum adjusted by the factor of 1.000XXX" and tied to the TGRN. The "1995" refers to the year of the most recent adjustment of coordinate values in Tennessee and 1.000XXX refers to the actual datum adjustment factor used for the project.

### 1.9.2 Construction Plan Submittal

The plan submittal shall consist of neat, scaled drawings with specifications and any other pertinent supportive data as required for review approval. These drawings shall include all aspects of the street, grading and drainage, including documentation or supporting evidence that proves sufficient engineering calculations have been performed in accordance with the approved project. The construction drawings and drainage calculations shall bear the stamp of a Registered Tennessee Professional Engineer. Other submittals for approval which are necessary and to be done by the

Developer may include, but are not limited to the Franklin Planning Commission; the Tennessee Department of Transportation, the Tennessee Department of Environment and Conservation, and the Tennessee Division of Water Pollution Control, Natural Resources Section.

As a general guideline, the *supporting calculations shall include any engineering information that is pertinent to the project*. These may include, but are not limited to the following:

- Drainage calculations including culvert and bridge analysis, drainage areas, runoff values, energy dissipators
- Intersection sight distance calculations
- Quantity calculations (City projects)
- Structural calculations

The designer is encouraged to add notes on the plans explaining special situations or items which are not readily apparent and that would influence the proposed design. The following sheets and information will be reviewed for quality assurance at this submission:

Title Sheet – Information on the title sheet shall include the following:

- Project numbers
- Project location map including north arrow and scale
- Description of project work type
- Reference points at the beginning and end of the project
- Project lengths, including incidental construction
- Design data including design speed, design criteria, functional classification, terrain, traffic data, etc.
- Signature block

Index and General Notes Sheet – Provide a list of utility owners and addresses that will be affected by the project. The index blocks shall be completed to indicate the sheet numbers for the plans.

Typical Cross Sections – These should show basic configuration and design features. This will typically include the following:

- Lane and shoulder widths tied to centerline
- Construction centerline
- Profile Grade Line
- Cross slopes
- Pavement Design
- Station ranges/limits
- Curbs
- Sidewalk locations and widths
- Bicycle facilities
- Side slopes
- Shoulder configurations if warranted
- Retaining walls, culverts, and bridges if warranted
- Ditches, Seed/Sod areas

Plat Sheet/Property Map – (if required) shall be included for projects that require acquisition of right-of-way.

Plan and Profile Sheets - Elevations and grades of special ditches shall be shown so that accurate right-of-way requirements can be determined. Typically, the plan view and profile shall be shown on the same sheet. In addition to the criteria required for the previous submittal, the plan and profile sheets shall include the following:

- Horizontal alignment (e.g., horizontal curve data, PC, PI, PT, bearings)
- Vertical alignment and its relationship to grade controlling features
- All alignment controlling features (e.g., high-water levels, existing cross roads and bridges, regulated drains, drainage structures, railroads, under drain criteria, traffic maintenance considerations, cemeteries, historical buildings, parks, ADA requirements, etc.)
- Preliminary drainage details, e.g., bridges and mainline culverts.
- Project limits
- Drainage features (e.g. pipe structures, ditch grades, preliminary inlet spacing for storm-sewer trunk line designs, etc.) and proposed drainage notes
- Public road approach and drive locations
- Construction limits
- Proposed right-of-way
- Approximate roadside barrier locations
- Permanent erosion protection
- Index and general notes sheet shall be up-to-date and accurate.
- The plan and profile sheets shall reflect correct structure notations, sodding, rip-rap and paved sodded ditch locations shall be indicated; earthwork balances are shown for City projects; and removal items are noted.
- If the project is to be funded by the City, tabulated values shall be included in the plan sheets that show quantities of all needed items.
- North Arrow and Scale for each sheet

Cross Sections – The cross sections shall include the following:

- Profile grade line
- Templates of the typical section placed on the existing cross sections
- Drainage structures
- Approaches and drives
- Clearance to buildings
- Final structure notation and final earthwork areas and volumes

Detail Sheets – The proposed layouts shall be included as follows:

- Turning movements and turn lanes
- Pavement markings
- Signals
- Signs, including sign structures
- Lighting
- Retaining walls
- Special drainage structures
- Superelevation transition diagrams
- Plans for temporary erosion control, traffic maintenance details, and traffic design elements (e.g., intersections, signals, signing and lighting).



Traffic Maintenance Details – The proposed traffic maintenance scheme and phasing shall be outlined and may be accompanied with “TDOT Standard Specifications”.

Structure/Drainage Data Table – The preliminary information to be included in the structure data table is as follows:

- Location
- Size
- Type
- Approximate elevations and grades where necessary for clarity
- Type of headwall

Design Information - In addition to the plans, the designer shall include copies of the hydraulic analysis for mainline culverts and bridges, if applicable, and results of any economic analysis that may have been completed for alternative grade lines.

Cost Estimate – A construction cost estimate is required for City funded projects only. Quantities for all major items shall be included in the cost estimate. Miscellaneous pay items previously accounted for as a percentage of the cost estimate and which are not required to complete tables in the plans do not need to be quantified.

### **1.9.3 Revision of Plans**

Should, prior to, or during construction, necessary changes be anticipated that would in the opinion of the City staff constitute significant revision of the plans already approved by the City, said plans shall be revised with said changes shown and resubmitted along with a letter stating why such changes are believed necessary. Changes deemed to be minor in nature by the Street Department Director may be made during construction with the changes noted for inclusion in the "as-built" drawings to be submitted to the City prior to final acceptance.

The City Engineer shall have the right to re-review the entire set of Plans should a revision of the plans be required.

---

## **1.10 Plan Review Procedure / Fees**

After receiving approval of the Preliminary Plat, Final Plat, Development Plan, and/or Site Plan, the Developer or Developer’s Engineer shall submit construction drawings for approval.

### **1.10.1 Submittal Requirements and Fees.**

Submittal Requirements and Fees can be found in the Municipal Code and the Administrative Manual.

### **1.10.2 Approval of Drawings and Fees, On-site Approved Drawings Required**

The City Engineer must approve plans, calculations and fees prior to the start of any work on the project. A complete set of approved Plans shall be available at the construction site at all times. Plans will not be deemed approved until the City Engineer and Street Department’s stamps of approval have been affixed to the cover sheet of the drawings and specifications.

### **1.10.3 Expiration of Construction Drawings**

Expiration of the construction drawings shall coincide with expiration of the Site Plan as per the applicable Franklin Zoning Ordinance.

---

### **1.11 Utility Coordination**

Locating and coordination for the relocation of existing utilities within the City's right-of-way is the responsibility of the contractor. Tennessee's One-Call shall be utilized in addition to coordination with local utility owners. The contractor shall at all times protect existing utilities and will be responsible for costs due to damage caused to any utility lines.

---

### **1.12 Historical Research Resources**

It is the responsibility of the contractor and designer to identify historic properties and to submit and follow plans that take these into account. Record searches can be performed at the Tennessee Historical Commission (THC), which houses the Tennessee State Historic Preservation Office. THC is located in Nashville and is the central repository for information on architectural surveys for the state of Tennessee. Their records can assist the contractor and designer in determining properties along the project corridor that have been listed in the National Register of Historic Places or if they have been inventoried in past surveys. Any records of historic properties shall be noted on the construction plan as measures taken to avoid such properties.

---

### **1.13 Permits**

Prior to beginning any construction, the Developer and/or Contractor, shall obtain all necessary permits as required by law. Such permits may include, but are not limited to, those required by State of Tennessee, Williamson County and the City.

Prior to beginning any construction activities, the Developer shall obtain all necessary City permits as outlined in Franklin Municipal Code, which may include, but are not limited to, Stormwater Management & Grading Permit, Excavation/Road Bore Permit, Demolition Permit, Building Permit, etc.

---

### **1.14 Notification of Construction**

In addition to any other notices required by law (e.g., TN One Call, notices to non-participating utilities), before commencing any street construction operations, a 72 hour notice must be given during regular business hours to the Engineering Department (Traffic Operations Center) and Streets Department.

---

### **1.15 Quality Control Testing**

Construction materials, including aggregate base stone, asphalt, concrete, and roadway sub-grades shall be fully tested in accordance with the designations and requirements within the referenced "TDOT Standard Specifications" sections. Unless otherwise noted within the "Standard Specifications" section, the type and number of tests called for by the referenced standards shall be performed.

Testing shall be done by an independent testing laboratory whose qualifications are approved by the City. Testing results will be submitted to and approved by the City Engineer. The City reserves the right to require industry standard certifications of testing and inspections by the testing laboratory, mills, shops and factories. Such certifications required shall be submitted in duplicate.

The Developer shall provide the necessary labor and supervision required to support field testing by the independent testing firm and inspections by City officials at no cost to the City. Test reports of field testing if applicable shall be submitted directly to the City Engineer. Defects disclosed by tests shall be rectified at no cost to the City. The Developer is required to have the design engineer or a certified quality control inspector present during all phases of construction. A daily log of work performed shall be kept by this individual and submitted to the City upon request.

---

### **1.16 Inspection**

All projects shall be subject to inspection during and upon completion of construction by an authorized representative(s) of the City. Presence or absence of an inspector during construction does not relieve the Developer and/or Contractor from adherence to approved plans and material contained in these Standards or from liability. Materials and/or workmanship found not meeting requirements of approved plans and specifications shall be immediately brought into conformity with said plans and specifications.

An authorized representative of the City shall make a final inspection of the project after completion to determine acceptability of the work and for release of performance bonds if required. Before this final inspection can be made, the Engineer responsible for the project shall certify in writing to the City Engineer that the work has been completed in accordance with approved plans and specifications.

The cost for inspection during construction is calculated and paid as part of the Grading and Stormwater Permit. Additional inspection fees will be required only when an inspection requiring City approval fails and requires subsequent re-inspections. The Inspection Fee (current prices can be found in the City of Franklin Municipal Code) shall be paid to the City before issuance of Permits.

Drainage facilities including, but not limited to, culverts, detention basins and ditches, as well as the roadway sub-grade, base stone and binder & surface coarse shall be inspected, tested and given approval at each stage of installation prior to proceeding to the next stage of construction. Final construction inspection for approval and acceptance of streets and drainage systems will not be granted until all work has been completed in accordance with the approved plans.

---

### **1.17 As-Built Plan Submittal**

Final as-built plans shall be submitted immediately following completion of construction activities. If the project is developed in phases, as-built plans for each phase shall be submitted once the work is complete in that phase. Acceptance of Facilities will not be issued until satisfactory as-built plans have been approved by the Street Department Director and the City Engineer.

All aspects of the project that have been affected by construction shall be verified and appear on the as-built plans. This would include, but is not limited to the following items:

- All property lines and easements
- Existing structures (Include patio covers, decks, trellises, sheds, pools, fences, poles, etc.)
- Location of all "as-built" work with station and offsets
- Height and location of all fences, walls, screens, tress and hedges over 42" tall
- All commercial driveways, paved areas, and required parking spaces
- All concealed components with station and offsets (include known buried cables, utilities, drainage structures, etc.)
- Video documentation of storm drainage
- Stormwater BMP'S (Detention/ Retention ponds, Bioretention Areas, etc.)

- All Utilities

Public or private stormwater infrastructure with nominal size of 12 inches or greater shall be video-inspected to verify proper installation, and the video recording and associated inspection report shall be submitted as part of the as-built record. The professional preparing the video shall be certified by the Pipeline Assessment and Certification Program (PACP). Video documentation shall be prepared in conjunction with the preparation of drainage as-builts and shall be provided no more than 90 calendar days prior to a performance release request submittal. Additional testing may be required if warranted by the video inspection.

Other concealed components shall require documented proof to be submitted with the as-built plans in the form of a certified construction log that has been generated by the design engineer or a certified quality control inspector as detailed in Section 1.10 of these Standards.

As-built plans are required to be *endorsed by a Tennessee registered professional engineer and or a registered land surveyor.*

---

### **1.18 Acceptance of Facilities**

After construction has been completed, a final inspection will take place by the City. City acceptance occurs when the Franklin Municipal Planning Commission releases performance bonds. Acceptance will occur once all contractual agreements have been met and construction meets the extents considered satisfactory under these Standards and deemed as such by the City.

Acceptance will only be issued after As-Built plans that adhere to requirements listed in these Standards have been submitted and approved by the City Engineer.

In the event of requests for acceptance of streets meeting development build-out requirements, but fronting a remaining vacant building lot, the developer shall post a Lot Bond for the vacant lot to insure protection of the as-built street improvements. Such bonds shall meet the requirements of Franklin Municipal Code, regarding Lot Bonds.

---

### **1.19 Existing Streets**

Existing streets serving a proposed development shall make offsite safety improvements in accordance with these Standards as determined by the City Engineer.

---

### **1.20 Modification of Engineering Standards**

The purpose of a modification of engineering standards is to provide limited relief from requirements of these Standards in cases where strict application of a particular requirement would create an exceptional hardship prohibiting the use of land in a manner otherwise allowed under these Standards. Self-imposed hardships, or actions taken by the applicant rather than conditions unique to the land in question, shall not be grounds for a modification of engineering standards.

A modification of engineering standards is not intended to remove inconveniences or financial burdens that the requirements of these Standards may impose of property owners in general.

A request for modification of engineering standards shall be made to the City Engineer in the form of a letter prepared by a licensed professional engineer. Each request shall include the following information. Incomplete requests shall be grounds for denial.

- 1) Documentation of the exceptional hardship and justification for the request;
- 2) Identification of the standard to be modified;
- 3) Identification of the alternative design or construction standard proposed;
- 4) Cost impacts to the City, including maintenance and replacement costs; and
- 5) Seal of the licensed professional engineering preparing the request.

The modification of engineering standards shall be considered by the City Engineer on a case-by-case basis and a determination shall be made using the following criteria:

- 1) Demonstration of an exceptional hardship due to unique physical surroundings, property shape, or topographical conditions of the property involved;
- 2) The granting of the modification shall not be detrimental to the safety, health, or welfare of the public, or injurious to other property or improvements;
- 3) The modification complies with acceptable engineering standards; and
- 4) The modification shall not place an undue financial burden on the City.

In approving modifications of engineering standards, the City Engineer may impose such conditions as in his or her judgement, shall secure substantially the objectives, standards, and requirements of these Standards.

---

### **1.21 Appeal of City Engineer Order or Decision**

Any person aggrieved by any order or determination of the City Engineer may appeal said order or decision to the Building and Street Standards Board of Appeals, established in Franklin Municipal Code, and have such order or determination reviewed by the Building and Street Standards Board of Appeals. A written notice of Appeal shall be filed with the City Engineer, and such notice shall set forth with particularity the decision, action or inaction of the City Engineer complained of and the relief sought by the person filing said Appeal. See City of Franklin Municipal Code for additional details.

---

### **1.22 Revisions to these Standards**

Per the Franklin Municipal Code Chapter 11, Title 16, Section 16-1101, major revisions to these Standards shall be adopted by ordinance of the City Board of Mayor and Aldermen; however, the City Engineer shall have the authority to issue minor revisions to the adopted standards for such items as administrative changes, error corrections, and clarifications that do not substantially alter the content or intent of the street specifications.



## STREET DESIGN

Section	Section Title	Article	Article Title	Pg
2.1	Standards for Design	2.1.1	General	2-3
		2.1.2	Location and Layout of New Streets	2-3
		2.1.3	Traffic Impact Analysis	2-4
		2.1.4	Connectivity	2-4
		2.1.5	Private Streets	2-5
2.2	Street Classification and Right-of-Way	2.2.1	General	2-5
		2.2.2	Street Classifications	2-5
		2.2.3	Cross Sections	2-6
		2.2.4	Right-of-Way and Easements	2-6
2.3	Design Criteria	2.3.1	Desired Operating Levels of Service	2-8
		2.3.2	Design Traffic Level	2-8
		2.3.3	Design Vehicle	2-8
		2.3.4	Min. Turning Paths of Design Vehicles	2-11
		2.3.5	Design Speed	2-11
		2.3.6	Street and Lane Widths	2-11
		2.3.7	Special Street Configurations	2-12
		2.3.8	Horizontal Alignment	2-15
		2.3.9	Vertical Alignment	2-17
		2.3.10	Sight Distance	2-19
		2.3.11	Lane Transitions	2-20
		2.3.12	Auxiliary Lanes	2-20
		2.3.13	Intersections	2-21
		2.3.14	Sidewalks, Curbs & Gutters, Shoulders and Ditches	2-32
		2.3.15	Medians	2-34
		2.3.16	On-Street Parking	2-35
		2.3.17	Bridges	2-38
		2.3.18	Clearance Requirements	2-38
		2.3.19	Barriers and Fencing	2-38
		2.3.20	Provision for Utilities	2-39
2.3.21	Emergency Access Street Requirements	2-44		
2.3.22	Bus Stops	2-44		
2.3.23	Access Management and Design	2-45		



Section	Section Title	Article	Article Title	Pg
2.4	Pedestrian Facilities	2.4.1	ADA Requirements	2-58
		2.4.2	Typical Sections	2-58
		2.4.3	Managing Access for Pedestrian Safety	2-58
		2.4.4	Intersections	2-58
		2.4.5	Sidewalk Ramps	2-58
		2.4.6	Corners	2-58
		2.4.7	Crosswalks	2-59
		2.4.8	Detectable Warning Surfaces	2-60
		2.4.9	Transit Stops	2-60
		2.4.10	Grade-Separated Pedestrian Crossings	2-60
2.5	Bicycle Facilities	2.5.1	Types of Facilities	2-60
		2.5.2	Bicycle Shared Streets	2-60
		2.5.3	Multi-use Paths / Greenways	2-61
		2.5.4	Bicycle Typical Sections	2-61
		2.5.5	Intersections	2-61
2.6	Traffic Calming	2.6.1	General	2-62
		2.6.2	Traffic Calming Design Criteria	2-63
		2.6.3	Traffic Calming Techniques	2-63

## 2.1 Standards for Design

The purpose of this chapter is to present the City criteria and guidelines for the design of streets and other related elements in the street right-of-way. It is to be used by the City, developers and their engineers in the design of public and private streets for which approval by the City Engineer is required. This chapter is not intended to address streets in the downtown urban core of the City, or streets in designated historic districts, however, certain criteria and guidelines in this chapter may be determined to be applicable to streets in these areas in order to preserve the public health, safety and welfare, as determined by the City Engineer.

### 2.1.1 General

All design drawings and support data submitted to the City Engineer for approval must be sealed by a registered Professional Engineer, licensed to practice in the State of Tennessee.

The design criteria, as presented, are intended to aid in preparation of plans and specifications, and include minimum standards where applicable. These design criteria are considered minimum and a complete design will usually require more than is presented in this document. Design of streets shall follow "*TDOT Standard Specifications*" unless otherwise noted in these Standards. For items not addressed in "*TDOT Standard Specifications*", AASHTO's "*Green Book*" and other relevant AASHTO design documents shall be consulted for guidance. Where conflicts exist or interpretations are required, the City Engineer shall make the final determination in consultation with the designer.

### 2.1.2 Location and Layout of New Streets

The location and layout of new streets shall be as identified in the Major Thoroughfare Plan, Subdivision Regulations and the Franklin Zoning Ordinance. Streets not identified in the Major Thoroughfare Plan shall meet the needs of the specific development and satisfy all other specific requirements of this chapter. The City Engineer retains the authority to designate collector and arterial streets as needed for circulation and emergency access and retains authority for approval of the overall street layout.

All streets shall have a logical relationship to the existing topography and to the location of existing, platted or planned streets within adjacent properties. In instances where a proposed street is not indicated on the Major Thoroughfare Plan, it should support a rectangular grid or modified grid street network to the maximum extent practicable. Curvilinear street networks shall only be used when topographic or environmental constraints make use of the grid pattern undesirable, or when established development patterns on adjacent lands make the grid pattern infeasible.

The street layout for all subdivisions shall be designed to ensure connectivity, enhance general circulation and to provide secondary points for emergency access. They shall also provide safe, efficient, and convenient vehicular, bicycle, and pedestrian access within and between developments. Certain streets may need to be extended to property boundaries to provide for the future logical extension of the street through adjacent properties. If an arterial or collector street is located within or adjacent to a development, the development shall continue the street to a logical termination point as determined by the City Engineer.

A major component in street layout is neighborhood traffic safety. This is an essential transportation issue in the City. Streets shall be designed to limit excessive traffic speeds and volumes in neighborhoods and provide for safe travel for all modes of transportation including pedestrian, bicycle, and vehicles. In addition, new streets in neighborhoods shall be laid out to minimize opportunities for cut-through traffic.

### 2.1.3 Traffic Impact Analysis

The City Engineer or his/her designee may require that a transportation impact analysis (TIA) be prepared for developments or projects meeting the criteria specified in this Subsection. The TIA shall consider traffic capacity and service, traffic controls, intelligent transportation systems (ITS), multi-modal accommodations and safety issues in accordance with the following standards:

#### (1) When Required

A TIA shall be required to assess the transportation impacts of a proposed development or project when:

(a) The expected number of primary trips generated by a proposed land use exceeds an estimated 1,000 vehicle trips per day or 100 peak hour vehicle trips per day; or

(b) A proposed land use generates less than 1,000 vehicle trips per day, or 100 peak hour vehicle trips per day when:

- i. The use is on a site located at or near existing or planned signalized intersections; or
- ii. The proposed land use may constitute a threat or danger to the safe and efficient flow of traffic, as determined by the City Engineer or his/her designee.

(c) The City Engineer or his/her designee may waive this provision if a recent, valid traffic study has been completed from which needed traffic impacts and mitigations can be extrapolated.

(d) When a development or project is subject to a land use plan amendment and/or rezoning, said land use plan amendment and/or rezoning application shall be accompanied by a new or updated TIA. At a minimum, the TIA shall provide information on both the existing Level of Service and future Level of Service based on the land use plan amendment and/or rezoning being proposed. This information shall be considered by the City of Franklin Board of Mayor and Aldermen when considering a land use plan amendment and/or rezoning. The Board of Mayor and Aldermen, at their discretion, may require system improvements to mitigate the traffic impacts resulting from a proposed land use plan amendment and/or rezoning, and may require said system improvements to be made by the applicant as a condition of approval. Any subsequent Development Plan associated with an approved land use plan amendment and/or rezoning shall be required to update the original TIA.

#### (2) Preparation of TIA

Reference the City of Franklin Traffic Impact Analysis (TIA) Guidelines on the City of Franklin Engineering webpage for TIA preparation requirements.

### 2.1.4 Connectivity

Plans shall achieve internal street connectivity by providing multiple connections to the existing city street network and adjacent lots wherever possible, and in accordance with these Street Standards.

#### (1) Single Street Access

In no case shall a single street or portion of a single street provide the sole access to more than thirty (30) single-family residential units.

#### (2) Cul-de-sacs

Cul-de-sacs are permitted only where allowed by the Franklin Zoning Ordinance. Where cul-de-sacs are created, at least one eight-foot-wide pedestrian access easement shall be provided, to

the maximum extent practicable, between each cul-de-sac head and the sidewalk system of the closest adjacent street or pedestrian sidewalk or pathway.

#### **2.1.5 Private Streets**

Private streets serving more than one lot shall be built to the same standards as required for public streets and shall be located in a public utility drainage and access easement (PUDAE).

---

## **2.2 Street Classification and Right-of-Way**

### **2.2.1 General**

Listed below are the classifications of public streets used in the City. These classifications primarily provide different levels of emphasis in regard to traffic movement versus direct access to property. Transportation improvements developed in accordance with the street classification system will help to discourage through traffic from using local neighborhood streets, and local traffic from congesting regional travel facilities. This will not only improve the efficiency of the transportation system in the City, but will also maintain the livability of its neighborhoods.

The City Major Thoroughfare Plan specifically identifies all streets classified as Freeways, Expressways, Arterials and Collectors in the City. Streets without one of these classifications shall normally be considered a Local street. However, the City Engineer shall have the authority to verify all street classifications for the purpose of applying street design standards.

### **2.2.2 Street Classifications**

#### **(1) Freeways and Expressways**

A divided arterial highway designed for the unimpeded flow of large traffic volumes. Access to a freeway is rigorously controlled and intersection grade separations are usually required. All freeways and expressways in the City are anticipated to be owned and designed by the Tennessee Department of Transportation (TDOT).

#### **(2) Arterial Streets**

Arterial streets are intended to primarily serve moderate to high traffic speeds and volumes within and through the City. Arterial streets may provide some access to abutting property, but only as it is incidental to the primary functional responsibility of travel service for major traffic movements. Arterial streets are classified as either Major Arterials or Minor Arterials depending upon expected traffic usage and adjoining property access.

#### **(3) Collector Streets**

Collector streets are intended to primarily serve slow to moderate traffic speeds and volumes and to distribute traffic from the arterials throughout the City to other collectors, arterials and local streets. Collector streets shall provide both land access service and traffic circulation within residential neighborhoods and commercial and industrial areas. Collector streets will be classified as either Major Collectors (further broken down to commercial/industrial or residential), or Minor Collectors depending upon expected traffic usage and adjoining property access. Major Collector streets may have limited driveway access to maintain the street's ability to achieve a safer and efficient traffic flow.

#### **(4) Local Streets**

Local streets are intended to primarily serve slow speeds and volumes and to provide access to abutting lands and connections to the higher street classifications. Local streets are to be

planned so that future urban expansion will not require the conversion of local streets to collector or arterial streets. Local streets may be commercial/industrial or residential depending upon the type and extent of the development and zoning they serve. Local streets may be terminated by a “cul-de-sac” where necessary due to topographic or other constraints.

**(5) Alley / Mews**

Alleys and mews are intended to primarily serve very slow speeds and volumes associated with the rear access and service functions for residential and commercial properties. Mews are a special type of alley that serves as the only vehicular and emergency access for lots abutting the mews. No vehicle parking area, fence, structure, vegetation, or wall shall be erected, maintained, or planted within the alley / mews right-of-way or within two feet of the edge of the alley / mews pavement/curb, whichever is greater.

**(6) Private Streets**

Private streets are streets that provide access to more than one lot but are not owned, operated and maintained by the City. Private streets shall be required to meet City design standards as determined by the City Engineer.

**(7) Frontage Roads**

Frontage roads are streets that normally run parallel to major roadways, usually arterials, to provide access to adjacent properties. Such streets greatly reduce the level of private driveway access to the major streets. Frontage roads are not typically used in the City and must be approved in advance by the City Engineer.

**2.2.3 Cross Sections**

Typical features and dimensions of standard City streets are illustrated in the Typical Section Drawings. These standard sections may be revised by the City Engineer on a case-by-case basis, to meet specific needs that may exist, or are projected to exist, along a particular street section.

**2.2.4 Right-of-Way and Easements**

**(1) Right-of-Way**

Minimum right-of-way widths shall be as shown in **Table 2.2 (1)** and in the street classification typical cross section drawings at the end of this chapter. Topography, special design features and other factors may require widths greater than these minimums. The City Engineer shall have final review with determination of any additional right-of-way that is required for the design of a specific street segment.

**(2) Easements**

There are several types of street-related easements allowed in the City.

- i. Public Utility, Drainage and Access Easement (PUDAE) that shall be approved for use by the City Engineer on a case-by-case basis.
- ii. Public Utility and Drainage Easement (PUDE) that shall be approved for use by the City Engineer on a case-by-case basis.
- iii. Public Access Easement (PAE) that allows multiple users of an access to the street.
- iv. Public Drainage Easement (PDE) for drainage purposes only.
- v. Slope Easement (SE) that provides for slopes between the street right-of-way and adjacent property.
- vi. Temporary Construction Easement (TCE) that may be used to provide adequate construction area in the construction of a street project.

### **(3) Improvements in Right-of-Way**

It is the policy of the City to place all permanent public streets, traffic signals, equipment, traffic signs and street-related features in public street right-of-way, with fee simple ownership by the City.

### **(4) Additional Right-of-Way Widths on Existing Streets**

Developments that adjoin existing streets shall dedicate additional fee simple right-of-way, where necessary, to meet the minimum requirements for the functional street classification of the existing street, or other dimensions as required by the City Engineer. This dedication shall be as follows:

- i. The entire right-of-way shall be provided where any part of the development is on both sides of the existing street.
- ii. When the development is located on only one side of the existing street, one half (1/2) of the required width of the right-of-way, measured from the center line of the existing roadway, shall be provided. If the development provides improvements to the existing roadway that shifts the centerline of the roadway, then the one half (1/2) of the required width of the right-of-way shall be measured from the new center line of the roadway.
- iii. When required by the City Engineer, additional right-of-way shall be required to accommodate future roadway improvements.

### **(5) Dedication Process**

The dedication of right-of-way and easements for street purposes shall normally occur through the platting process. When dedications are required outside the platting process, they shall be dedicated in a manner and format approved by the City Engineer and City Attorney.

---

## **2.3 Design Criteria**

The design criteria presented in this section apply to all roadways that are required to be designed and constructed to City standards and specifications. The design criteria presented below shall be used as minimum requirements for new developments and may be increased at the direction of the City Engineer if warranted by safety hazards or traffic operations.

The City Engineer, in consultation with other City departments and State agencies, may allow modifications to the design criteria set forth in this chapter. Modifications may be necessary to allow private or public construction to be compatible with in-place improvements or to address unusual circumstances that justify an alternative design or criteria. Modifications to design criteria may be allowed provided that an investigation by the City Engineer concludes that all of the following criteria can be satisfied.

- The modification to the design criteria is based on sound engineering principles and practices.
- The modification to the design criteria will not create an unsafe or hazardous situation to occur.
- The modification to the design criteria will be equivalent to the minimum criteria set forth herein in terms of functionality, efficiency, durability, structural integrity and long term maintenance.
- The modification to the design criteria will not adversely impact adjacent properties or individual property owners, provided that safety is not compromised.

The City Engineer is authorized to require studies or other pertinent information to be provided by the petitioner to help support or validate the modification request at no cost to the City. See **Chapter 1** for additional information on the variance process.



All streets are to be designed in accordance with the design speeds specified for each street classification in this chapter, or as amended by the City Engineer, and as summarized in **Table 2.3 (1)** and **Table 2.3 (2)**.

### **2.3.1 Desired Operating Levels of Service**

Reference the Traffic Impact Analysis (TIA) Guidelines on the City of Franklin Engineering Development webpage for Level of Service requirements.

### **2.3.2 Design Traffic Level**

Streets shall generally be designed to accommodate projected future traffic conditions a minimum of twenty (20) years (or another target year agreed to in the Traffic Impact Analysis Memorandum of Understanding (MOU)) after the street is opened to traffic. These projected traffic conditions shall address total daily traffic loads along with directional distribution of the peak-hour loads. These loads shall address typical weekday conditions as well as off-peaks and weekend periods when applicable. Seasonal and special event conditions shall also be considered where appropriate as determined by the City Engineer.

### **2.3.3 Design Vehicle**

All streets shall be designed to accommodate the predominant type and composition of vehicles that can be reasonably expected to travel through them. At a minimum, for streets and intersections designed in the City, the vehicle types in **Table 2.3 (3)** shall be fully accommodated in the design process. For special circumstances other design vehicles may be required by the City Engineer.

TABLE 2.3 (1) STREET STANDARDS – GENERAL PARAMETERS						
Design Feature or Characteristic	Street Classification					
	Major Arterial	Minor Arterial	Major Collector	Minor Collector	High Volume Local	Low Volume Local
Minimum Lane Width	12'	12'	12'	12'	12'	11'
Median Width	40'	36'	30'	n/a	n/a	n/a
Curb & Gutter: Vertical or Mountable <sup>note b</sup>	V	V	V	V	V	V or M
Bike Lane Width	5'	5'	5'	5'	n/a	n/a
Parking Lane Width	n/a	n/a	n/a	8' <sup>note c</sup>	8'	8'
Sidewalk Width	6' or 8'	6' or 8'	6' or 8'	6' or 8'	5'	5'
Multi-Use Path Width	12'	12'	12'	12'	n/a	n/a
Grass Strip Width	6'	6'	6'	6'	6'	6'
Left Turn Lanes Req'd?	Yes	Yes	Yes	Yes	Yes	Yes
Right Turn Lanes Req'd?	Yes	Yes	Maybe	Maybe	No	No
Traffic Volume Capacity (1000 veh/day)	>35	20-35	15-20	10-15	2-5	<2
Speed Limit, MPH <sup>note a</sup>	45	40	35	30	25	25 or 20
Driveway & Street Access	Very Ltd	Limited	Limited	Frequent	Frequent	Unlimited
Continuity of Travel	Very High	High	Moderate	Low	Very Low	Very Low
Traffic Calming	None	None	None	None	Possible	Possible

NOTES: a. Design speed shall be a minimum of 5mph above the posted speed limit.  
b. Vertical curb requires shoulder separation from travel lane on posted speeds of 50 mph or greater.  
c. Parking Lane Width exclusive of gutter

**TABLE 2.3 (2) STREET STANDARDS – TECHNICAL DESIGN CRITERIA**

Design Element	Arterial		Collector		Local		Alley / Mews	
	Major	Minor	Major	Minor	High Volume	Low Volume		
<b>Overall Design Parameters</b>								
Design Speed/Posted Speed	50 / 45	45 / 40	40 / 35	35 / 30	30 / 25	25 / 25 or 20	15 / 15	
Min Stopping Sight Distance <sup>Note a</sup>	425'	360'	305'	250'	200'	115'	80'	
Passing Sight Distance	1,835'	1,625'	1,470'	1,280'	n/a	n/a	n/a	
<b>Horizontal Alignment <sup>Note b</sup></b>								
Minimum centerline radius: with no super-elevation (NC)	1,391'	1,039'	762'	510'	333'	70'	55'	
with 0.02 super-elevation	1011'	794'	593'	408'	Not Allowed	Not Allowed	Not Allowed	
with 0.04 super-elevation	905'	711'	533'	371'	Not Allowed	Not Allowed	Not Allowed	
Maximum super-elevation	0.04 ft/ft	0.04 ft/ft	0.04 ft/ft	0.04 ft/ft	n/a	n/a	n/a	
Minimum tangent between curves or at intersections	200'	150'	150'	100'	100'	20'	0	
<b>Vertical Alignment</b>								
Maximum Centerline Grade %	6	7	8 <sup>note c</sup>	8 <sup>note c</sup>	8 <sup>note c</sup>	10 <sup>note c</sup>	8	
Minimum Gutter Flow-line Grade %	0.5	0.5	0.5	0.5	0.5	0.5-1.0	1.0	
Min. K-values for Vertical Curves (Stopping Sight Distance)	Crest	84	61	44	29	19	7	7
	Sag	96	79	64	49	37	17	17
<b>Intersection Design</b>								
Minimum sight distance at driveways and intersections (street and topographic features may increase these minimums)	See AASHTO "Green Book"							
<b>Access Management</b>								
Distance Between Intersections <sup>note e</sup>	Signalized	2,640'		1,320'	1,320'	n/a	n/a	n/a
	Non-signalized	1,200'	600'	300'	300'	200' <sup>note d</sup>	200' <sup>note d</sup>	n/a
Minimum distance between high volume driveways / alleys / mews & street or other high volume intersections <sup>note e</sup>	800'	600'	300'	300'	200'	200'	n/a	
Minimum distance between low volume driveways & street intersections <sup>note e</sup>	250'	250'	230'	230'	125'	50'	40'	
Minimum distance between low volume driveways <sup>note e</sup>	250'	250'	150'	150'	50'	20'	10'	

- NOTE:
- a. AASHTO "Green Book" latest standards supersede these requirements and shall be adjusted based on roadway grades.
  - b. AASHTO "Green Book" latest standards supersede these requirements. Requirements based on Low-Speed Urban Streets.
  - c. These dimensions may be increased or amended by the City Engineer as deemed necessary for safe and efficient street operations.
  - d. These distances may be reduced to 125 feet when both intersecting streets are cul-de-sacs.
  - e. Measured from the nearest points of radius returns

Table 2.3 (3) Design Vehicle Requirements	
Street Classification	Vehicles Accommodated
Alley / Mews	Passenger cars and single-unit trucks.
Local	Passenger cars, single-unit trucks (SU-30), and conventional school buses must be able to turn easily from one street to the next and remain in the correct lane for each street. Combination trucks (WB-50) shall be able to physically traverse local streets by using the full width of the traveled way if necessary, including intersection turns, and without tracking onto the curb at corners.
Minor Collector	Passenger cars, single-unit trucks and conventional school buses must be able to turn easily from one street to the next and remain in the correct lane for each street. Combination trucks (WB-50) shall be able to physically traverse the street by using the full width of the traveled way if necessary, including intersection turns, and without tracking onto the curb at corners.
Major Collector	Passenger cars, transit buses (S-40), single-unit trucks, conventional school buses and combination trucks (WB-62) must be able to turn easily from one street to the next and remain in the correct lane for each street, and without tracking onto the curb at corners.
Major and Minor Arterial	Passenger cars, transit buses (S-40), single-unit trucks, conventional school buses and combination trucks (WB-67) must be able to turn easily from one street to the next and remain in the correct lane for each street, and without tracking onto the curb at corners.
Freeway / Expressway	All approved vehicle types must be able to turn easily onto and off of Freeway/Expressway Ramps from adjacent streets and remain in the correct lane for each ramp/street. These are typically State of Tennessee roadways and shall meet all TDOT design vehicle requirements.

#### 2.3.4 Minimum Turning Paths of Design Vehicles

All street and intersection geometric designs shall be evaluated to ensure that the minimum turning paths for the selected design vehicles can be safely and efficiently accommodated by the proposed street and intersection geometry.

#### 2.3.5 Design Speed

There are two primary types of speeds that must be considered in the street design process. The first is “design” speed, which is the selected speed used to determine the various minimum geometric design features of the street. The second type is “operating” speed, which is the speed at which drivers operate their vehicles in free-flow conditions. The “85<sup>th</sup> percentile speed” (the speed at which 85 percent of the vehicles travel at or less) is generally assumed to be the operating (and typically posted) speed of a street.

The design speed selected for street design purposes shall take into consideration several factors including street classification, adjacent land use, topography and sight distance, pedestrian and bicycle activity, and the desired operating speed of the facility. The design speed used in street design shall be approved by the City Engineer and shall generally be in accordance with **Table 2.3 (2)** for desirable design speed by street classification.

#### 2.3.6 Street and Lane Widths

##### (1) Street Widths

The minimum width of a street pavement section shall be determined by (1) its functional classification as identified in the Major Thoroughfare Plan, and (2) typical cross-sections as shown in the Standard Drawings. Other elements such as topography and Traffic Impact Analysis (such as turn lanes and deceleration/acceleration lanes), and unique street design features may necessitate a change in the minimum street section width. The City Engineer will approve the final required street width.

## (2) Lane Widths

The minimum and desirable widths of different types of lanes based on the street classification are provided in **Table 2.3 (1)**, and as shown in the Typical Section Drawings. These widths may be modified by the City Engineer based on the specific requirements of a street section.

### 2.3.7 Special Street Configurations

#### (1) Cul-de-Sacs

**(a) Where Allowed:** Cul-de-sacs are permitted only on Local Street classifications and shall not extend for more than five-hundred (500) feet (unless necessitated by topography and approved by the City Engineer) as measured from the center of the cul-de-sac turn around to the nearest right-of way boundary of the adjoining street right-of-way intersection. If adjoining properties, commercial or residential, install fire sprinkler systems, this length may be extended to 1000 feet in accordance with the adopted fire code.



Typical Street Cul-de-Sac

**(b) Secondary Access:** Any Local Street with a cul-de-sac that exceeds the maximum lengths above shall be provided with a secondary access point.

**(c) Design Requirements:** Cul-de-sac streets shall terminate in a circular turn around having a right-of-way radius of at least sixty-five (65) feet, and a paved radius of at least fifty (50) feet at its outside edge. These and other minimum requirements are illustrated in the Standard Drawings.

**(d) Prohibited Designs:** All cul-de-sac designs must allow for automobiles and typical service vehicles to turn around without requiring backing maneuvers.

**(e) Temporary Cul-de-Sac:** Where a development is being implemented by sections, a temporary cul-de-sac may be used if the overall development plan allows the cul-de-sac to be eliminated at final build out of the development. Temporary cul-de-sacs shall be replaced with a street connection within three (3) years or less from the date construction starts unless otherwise approved by the Fire Marshall. The cul-de-sac shall be provided with an asphalt turn-around having a radius of at least fifty (50) feet. No designs requiring backing maneuvers will be allowed. The easement radius shall be a minimum of sixty-five (65) feet in areas where there is no adjacent public utility and access easement, and a minimum of sixty (60) feet where public utility and access easements are required and/or provided.

All temporary cul-de-sacs shall be constructed within dedicated street right-of-way or a dedicated Public Utility, Drainage and Access Easement for those areas outside the tangent street right-of-way section. The Easement outside the tangent right-of-way section shall be vacated by the City when the Easement is no longer necessary. Application for vacation of the easement must be initiated and paid for by the Developer or property owner.

A sign must be provided at the end of the temporary cul-de-sac noting that the street will be extended in the future. Signing for temporary, dead-end streets shall be in accordance with the requirements of the Standard Drawings.

**(f) Cul-de-Sac Medians:** Center median islands in cul-de-sacs are prohibited.

**(g) Cul-de-Sac Parking:** Parking in a cul-de-sac is prohibited. Four (4) "No Parking" street signs shall be evenly spaced around the perimeter of new cul-de-sacs.

## **(2) Eyebrows**

**(a) Where Allowed:** Eyebrows shall be permitted only on Local Streets. They may only be used in tangent sections or at intersection corners. Design of eyebrows shall be as shown in **Figure 2.3 (1)**.

**(b) Design Requirements:** Eyebrows shall be a minimum of twenty-five (25) feet in length and a maximum of fifty (50) feet measured along the flow-line. Lengths exceeding fifty (50) feet shall incorporate an island as approved by the City Engineer. Designs that require backing maneuvers for typical use vehicles are prohibited.



Typical Eyebrow

**(c) Location:** The location of the eyebrow shall be in conformance with intersection spacing requirements as provided in **Access Management Section**.

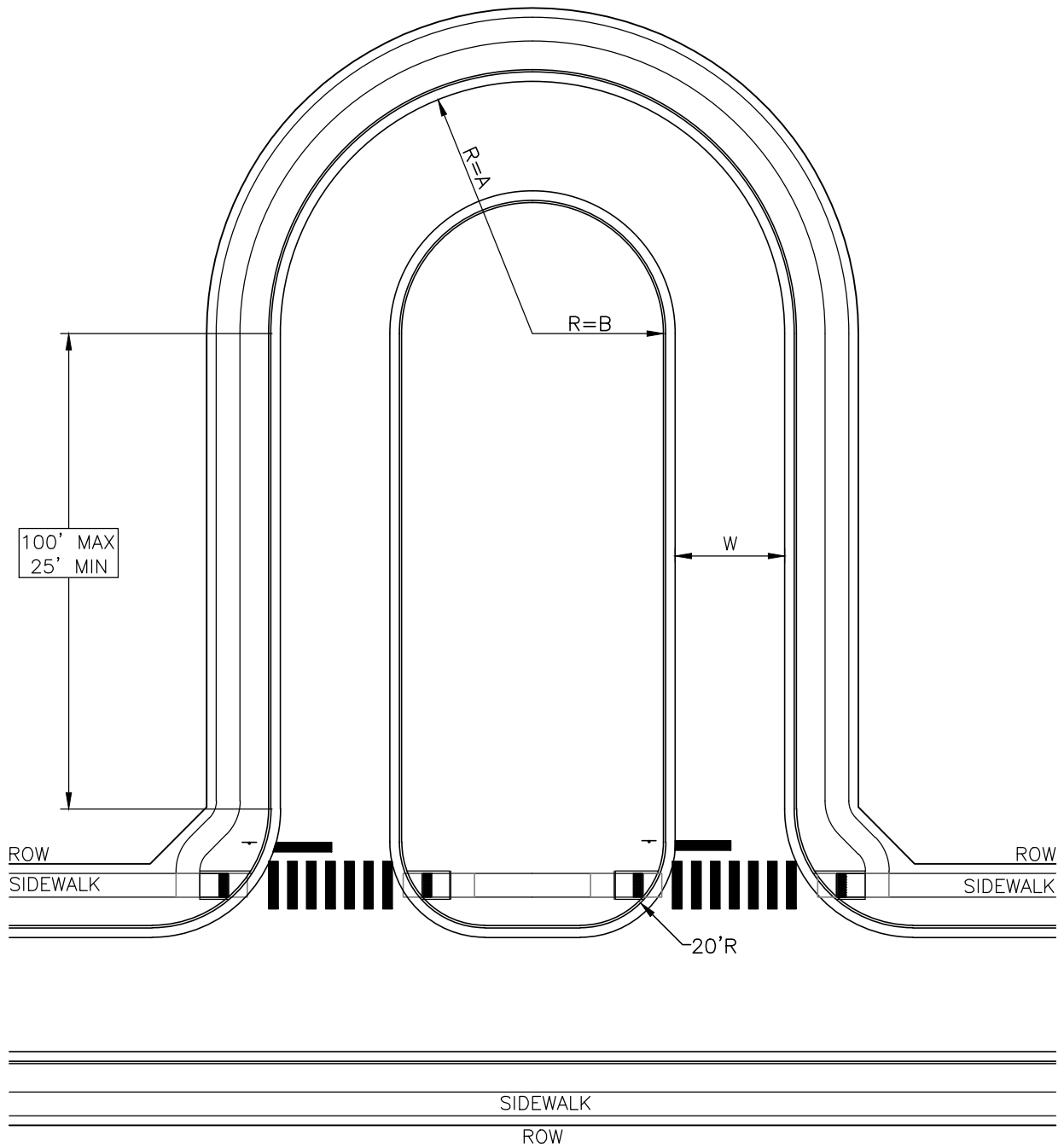
## **(3) Dead-End Streets**

**(a) Where Allowed:** Permanent dead-end streets without cul-de-sac designs are prohibited. Permanent dead-end alleys or mews with or without cul-de-sac designs are prohibited.

**(b) "Stub" Streets and Alleys / Mews:** Temporary dead-end "stub" streets and alleys / mews (without temporary cul-de-sacs) will only be permitted on local streets and alleys / mews at the discretion of the City Engineer. Stubs shall not be longer than one residential lot. See Standard Drawings for design requirements of temporary dead-end "stub" streets.

**(c) Signs Required:** A sign must be provided at the temporary street or alley / mews end noting that it will be extended in the future.





STREET CLASSIFICATION	RADIUS (MIN.)		NO PARKING W	PARKING	
	A	B (MAX)		ONE SIDE W	TWO SIDES W
LOCAL SINGLE FAMILY RESIDENTIAL	55'	30'	15'	23'	31'
LOCAL MULTIFAMILY RESIDENTIAL	60'	30'	22'	30'	38'
LOCAL COMMERCIAL & INDUSTRIAL	65'	26'	24'	32'	38'

- 1) THE SIDEWALK AROUND THE EYEBROW SHALL BE PLACED ACCORDING TO THE STREET CLASSIFICATION. THE SIDEWALK ACROSS THE STREET END OF THE ISLAND IS TO BE PLACED IN THE SAME LOCATION AS ON THE CROSS STREET.
- 2) MEDIAN MAY BE LANDSCAPED OR HARDSCAPED AS REQUIRED AND SHALL BE MAINTAINED BY THE OWNERS ASSOCIATION.
- 3) WHEN PARKING IS RESTRICTED TO ONE SIDE, IT SHALL BE PROVIDED ON THE OUT-SIDE OF THE STREET.



#### **(4) Half Streets**

The City Engineer may allow the construction of half streets on Minor Collector and Local streets when only one side of a street right-of-way is available. A minimum of twenty-two (22) feet of pavement must be provided on any half street. In such cases, the property owner is responsible for right-of-way dedication and construction of the half of the new street section that is adjacent to their property. Typically, these partial street sections will be built to permanent street standards including all curb and gutter, drainage, sidewalks and other elements as called for in the typical section for that street classification. Additional dedication of street easement may be required by the City Engineer in these cases.

#### **(5) Provisions for Future Public Street Intersections**

Where provisions are to be made to intersect a future side street with the street being designed, the curb radii and pavement section of the future intersecting street "stub" shall typically be built to the end of the radii curb return. If the expected construction of the future street connection is anticipated to occur more than three (3) years after the primary street is constructed, then the street approach "stub" may be omitted and temporary curb, gutter and sidewalk improvements provided through this section. In such cases, the curb and gutter shall be concrete while the temporary sidewalk or path may be asphalt.

#### **(6) Provisions for Future Public Street Widening**

Developments shall not hinder implementation of the full widened section proposed for existing streets as depicted on the Major Thoroughfare Plan. Grading within developments shall allow the full widened section to tie in using slopes no steeper than three units horizontal to one unit vertical (3H:1V), and without the need for retaining walls. Buildings, walls, stormwater features, and other constructed elements shall be located such that they do not require modification, relocation, or temporary shoring for implementation the full widened section. New access connections to existing streets shall be designed and constructed such that they will not require significant geometric modifications to continue to meet these Standards when the full widened section is constructed, as determined by the City Engineer.

#### **(7) Improvement of Annexed Streets**

Streets annexed into the City may be required to meet these engineering standards before they are accepted as City streets. The City Engineer shall evaluate all proposed street annexations to determine their adherence to these standards, and any recommendations for improvements to meet minimum public safety, health and welfare requirements.

### **2.3.8 Horizontal Alignment**

The design of horizontal curves in street design shall be based on an appropriate relationship between design speed and curvature and on their joint relationships with superelevation and side friction. On Arterial and Major Collector streets, curve radii and tangents shall be as large as possible using the minimums only where necessary. However, minimum radius curves shall be used on Local and Collector streets unless otherwise required. Angle point direction changes are not allowed. All changes in direction shall be made using standard curves.

#### **(1) Horizontal Curve Radii**

The minimum allowable centerline radii for horizontal curves shall be as designated in **Table 2.3 (2)**. Reverse and compound curves shall be used only when a single radius curve will not work. For driver safety, compound curves shall preferably have a ratio no greater than one and one-half (1.5) where the value of the larger radius is divided by the smaller radius. When they are designed, "*TDOT Standard Specifications*" and AASHTO's "*Green Book*" design standards and procedures shall be used.

Based on typical conditions in the City, the absolute minimum and desirable horizontal curves for streets without superelevation are shown in **Table 2.3 (2)**. This table also provides the minimum tangent distance between reverse curves.

The effect of grade shall also be considered by the designer when selecting horizontal curvature. The design of more complex horizontal curve geometry shall be conducted in accordance with "*TDOT Standard*

Specifications”, AASHTO’s “Green Book” and AASHTO’s “Guidelines for Geometric Designs of Very Low-Volume Local Roads (ADT ≤ 400)”.

**(2) Minimum Tangent Length**

**(a) Intersection:** Whenever a minor street intersects a street of higher classification, a tangent length (measured from the nearest gutter flow-line of the intersected street to the point of curvature in the intersecting street) shall be provided for a safe sight distance and safe traffic operation. The minimum required tangent lengths indicated in **Table 2.3 (2)** apply to the minor leg(s) only. The angle of departure shall not exceed ten (10) degrees for the length of the tangent.

**(b) Reverse Curves:** Reverse curves in streets shall be separated by minimum tangents of between two-hundred (200) and one-hundred (100) feet for arterial and major collector streets as shown in **Table 2.3 (2)**.

**(c) Broken Back Curves:** Two curves in the same direction (broken back curves) shall be separated by a tangent with a length of at least two (2) times the minimum length shown in **Table 2.3 (2)**.

**(3) Curves with Small Deflection Angles (10° or less)**

To reduce the appearance of kinks in the street, minimum lengths of curve shall be designed with minimum arc lengths as shown in **Table 2.3 (4)**.

<b>Table 2.3 (4) Minimum Centerline Arc Length</b>	
Street Classification	Minimum Centerline Arc Length (ft)
Local – Residential	100
Local – Commercial & Industrial	200
Minor Collector	250
Major Collector – Residential	250
Major Collector – Commercial & Industrial	300
Minor Arterial	300
Major Arterial	400

**(4) Horizontal Curves on Vertical Curves**

For driver safety, horizontal curves shall not begin near the top of a crest vertical curve nor near the bottom of a sag vertical curve.

**(5) Off-Site Design Centerline, Flow-lines and Cross Sections**

To assure that future street improvements will meet these Standards, the centerline, flow-line, and cross sections of all streets, except cul-de-sacs, shall be continued for five-hundred (500) feet beyond the proposed construction. The grade and ground lines of all arterials shall be continued an additional five-hundred (500) feet for a total of one-thousand (1000) feet beyond the end of the proposed construction.

**(6) Joining Existing Improvements**

Connection with existing streets shall be made to match the existing alignment grade of the existing improvements, in accordance with horizontal alignment criteria.

**(7) Cross Slope**

Cross slope on a pavement is provided to drain water from the street surface. The design of cross slope shall consider driver comfort and safety.

**(a) Minimum Cross Slope:** A minimum cross slope on all new streets shall be two (2.0) percent. Minimum cross slope on reconstruction or overlays is one and one-half (1.5) percent. All other values of cross slope shall be independently reviewed and approved by the City Engineer.



**(b) Maximum Allowable Cross Slope:** Maximum allowable tangent cross slope on all new construction shall be two (2.0) percent. Maximum allowable cross slope on any reconstruction or overlays of existing streets shall be four (4.0) percent.

**(c) Cross Slope for Street Modifications:** When widening an existing street or adding turn lanes to an existing street, the resulting cross slope of the widened portion shall be within the limits stated above and the new Cross Slope shall be no less than the existing cross slope. However, if the cross slope of the existing street exceeds the Standards then new curb and gutter shall be designed such that the existing pavement, when overlaid, will result in a straight line cross slope grade that meets these Standards. Alternatively, the existing pavement may be removed and re-profiled to comply with these Standards.

**(d) Cross Slope for Cul-de-Sacs:** Cul-de-sac cross slopes shall not be less than two (2.0) percent nor more than five (5.0) percent, with two (2.0) percent being desirable.

#### **(8) Superelevation on Horizontal Curves**

The purpose of superelevating a street is to maintain the riding comfort on horizontal curves. Superelevation is not typically used on streets in the City with design speeds at or less than 30 MPH. For design speeds higher than 30 MPH or where superelevation is required or preferred, "TDOT Standard Specifications" and AASHTO's "Green Book" design standards and procedures shall be used. The following criteria shall be followed:

**(a) Where Superelevation Is Permitted:** Superelevation may be allowed for curves on Arterial and Collector streets. In no case shall superelevation exceed four (4.0) percent cross slopes. As specified in **Table 2.3 (2)**, superelevation shall not be used on Local Streets.

**(b) Transition Length:** When superelevation is used, use the TDOT method of a 50/50 split of the transition length each side of the tangent point

**(c) Drainage:** Where superelevation is used, the gutter shall always be an inflow type. The water must enter a storm sewer system or other acceptable outlet from the street rather than crossing the street in sheet flow. Where medians are present in a super-elevated section, water may be allowed to sheet flow from the median to the street gutter.

#### **2.3.9 Vertical Alignment**

The design of vertical curves in street design shall be simple in application and shall result in a design that is safe and comfortable in operation, pleasing in appearance and adequate for drainage.

##### **(1) Maximum and Minimum Grades for Streets**

The maximum and minimum grades for specific street classifications are shown in to **Table 2.3 (2)**. The centerline grade in the bulb of a cul-de-sac shall not exceed five (5.0) percent.

##### **(2) Grade Breaks**

No single point grade break shall exceed four-tenths (0.40) percent, except for the flow line in sag curves where the maximum grade break is one (1.0) percent. In curb returns, a grade break may be as great as three (3.0) percent for extreme circumstances.

##### **(3) Minimum Flow-line Grades**

Minimum flow-line grades for gutters shall be one-half (0.50) percent, except in the bulb of cul-de-sacs where the minimum shall be one (1.0) percent.

##### **(4) Grades Through Intersections**

The profile grade lines on the legs of an intersection shall be adjusted for a distance back from the intersection to provide a smooth junction and proper drainage. Normally, the grade line of the major street shall be carried through the intersection and that of the minor street shall be adjusted to it. Any changes in profile through an intersection shall meet the crest and sag curve criteria noted below, to the extent deemed practical. The City Engineer shall approve all variations from these criteria.

Intersection approach grades shall consider the deceleration and acceleration that occurs due to traffic control and turning movements. It is desirable to provide near-level intersection approach grades to improve operations and safety within the intersection area. Maximum intersection approach grades are shown in **Table 2.3 (5)**.

<b>Table 2.3 (5) Maximum Grades</b>		
Classification	Maximum Grade	Maximum Grade Approaching Signalized Intersection
Freeway	Determined by TDOT	n/a
Expressway	Determined by TDOT	2 % for 600 ft.
Major Arterial	6 %	2 % for 500 ft.
Minor Arterial	7 %	2 % for 500 ft.
Major Collector	8 %	3 % for 400 ft.
Minor Collector	8 %	3 % for 300 ft.
Local High Volume	8 %	4 % for 200 ft.
Local Low Volume	10 %	4 % for 100 ft.
Cul-de-Sac	5 %	n/a
Alley / Mews	8 %	n/a

**(5) Requirements for Using Vertical Curves**

The major control for safe operation on “crest” vertical curves is the provision of ample sight distance for the design speed. Crest vertical curves shall be designed to at least provide the minimum stopping sight distance as established in AASHTO’s “Green Book”.

The design of “sag” vertical curves is controlled by headlight distance, passenger comfort, drainage control and general street appearance. At under-crossings the structure may limit sight distance which could cause the need for higher K factors to achieve adequate stopping sight distance.

**(6) Joining Existing Improvements**

Connection with existing streets shall be made to match the existing grade of the existing improvements, in accordance with vertical alignment criteria (grade breaks shall not exceed allowable).

**(7) Vertical Clearance**

Vertical clearance above a street shall be a minimum vertical clearance of sixteen and one-half (16.5) feet. The City Engineer may require greater clearance when considered necessary to meet future street operation requirements.

**(8) Off-Site Continuance of Grade and Ground Lines**

To assure that future street improvements will meet these Standards the grade and ground lines of all local and collector streets, except cul-de-sacs, shall be continued on the plans for five-hundred (500) feet beyond the proposed construction. The grade and ground lines of all arterials shall be continued one-thousand (1000) feet beyond the end of the proposed construction.

**(9) Coordinating Horizontal and Vertical Alignments**

Horizontal and vertical design shall not be designed independently. Horizontal alignment and profile are among the more important design elements of a street. Their effective combination increases safety, encourages uniform speed, and improves appearance. Some general guidelines for their relationships are:

(a) Curves and grades shall be in proper balance. The designer shall not combine extreme horizontal and/or vertical conditions or introduce significant curves at the end of long tangent sections or flat grades.

(b) Sharp horizontal curvature shall not be introduced at or near the top of a pronounced crest vertical curve, nor shall it be introduced near the bottom of a steep grade approaching or near the low point of a pronounced sag vertical curve.

(c) Both horizontal and vertical curvature and profile shall be made as flat as practical at intersections where sight distance along both streets is important and vehicles may have to slow or stop.

(d) Designers should begin evaluating horizontal alignment and profile in the preliminary design stage. Proposed alignment and profile shall be submitted to the City for review and comment prior to advancing the design process.

### 2.3.10 Sight Distance

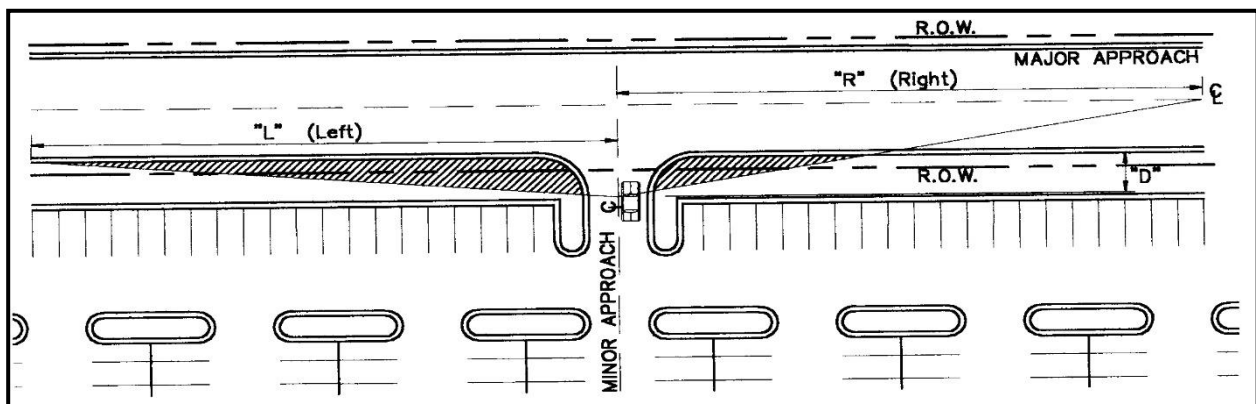
#### (1) General

Sight distance calculations shall be based on AASHTO's "Green Book" requirements.

All streets designed in the City shall provide adequate sight distance for all types of users, considering both horizontal and vertical alignment. Sight distance shall be carefully considered in the preliminary stages of design when both the horizontal and vertical alignment may still be subject to adjustment. Specific sight distance requirements include:

#### (2) Sight Obstructions

Any object within a sight distance triangle more than twenty-four (24) inches above the flow-line elevation of the adjacent street shall constitute a sight obstruction, and shall be removed or lowered. Such objects include but are not limited to berms, buildings, parked vehicles on private property, cut slopes, hedges, trees, shrubs, mailbox clusters, utility cabinets or tall crops. Since vehicles parked on-street are under the control of the City, parked vehicles shall not be considered an obstruction for design purposes. The city may limit parking to protect visibility as needed. The sight distance shall be measured to the approach lane positions as shown in **Figure 2.3 (2)**. In no case shall any permanent object encroach into the line-of-sight of any part of the sight distance triangle. Street trees within the sight distance easement may be excepted from this requirement if pruned up to eight (8) feet, and the trunks at maturity do not collectively hinder sight lines as determined by the City Engineer. The shaded portion of the diagram depicts the sight triangle area where site element heights and locations are strictly limited.



Intersection Sight Distance Triangle

Figure 2.3 (2)

During the street design process, the designer shall identify and correct for any sight obstructions that could limit the driver's sight distance beyond the distances noted above. This process shall investigate both the vertical and horizontal plane for sight obstructions. No landscaping or hardscaping shall be permitted within a corner area that will block the line of sight for pedestrian visibility (not higher than twenty-four (24) inches and possibly less depending on street geometry).

Street intersections shall be designed so that adequate sight distance is provided along all streets. The required sight distance shall be determined by the design speed and grades of the street and the acceleration rate of an average vehicle. In addition, for all streets that intersect with Arterial and Collector streets, the sight distance must be large enough to allow a vehicle to enter the street and accelerate to the average running speed without interfering with the traffic flow on the Arterial or Collector Street. Intersection sight distance is generally determined based on the different types of traffic control at an intersection. In most cases sight distance triangles will be required as described below. The different situations, or cases, that must be considered are defined in the following discussion.

### **(3) Sight Distance Easements**

All sight distance easements must be shown on the street plan/profile plans. All necessary sight distances must be within the public right-of-way or a sight distance easement dedicated to the City. When the line of sight crosses onto private property, a "Sight Distance Easement" shall be dedicated to provide the required clear sight distance. The easement or right-of-way shall be dedicated to the City; however, maintenance shall be the responsibility of a private entity such as the property owner or the appropriate home owners association (HOA).

#### **2.3.11 Lane Transitions**

Lane transitions are necessary when through lanes require lateral transitions without the use of horizontal curves. Also, when constructing a street that will directly connect with an existing street of different width, it is necessary to install a transition taper between the two. The length of taper depends upon the lateral offset distances between the outside traveled edge of the two sections and the design speed of the roadway. Formulas for determining transition taper lengths are shown below:

$$\text{For Speeds } \leq 40 \text{ MPH:} \quad L = \frac{W * S^2}{60}$$

$$\text{For Speeds } > 40 \text{ MPH:} \quad L = W * S$$

L = transition taper length, feet  
W = width of pavement offset, feet  
S = roadway design speed, MPH

When transition tapers are located on a curve, the separate halves of the roadway shall be designed with different curves to create the taper without any angle points in the curvature.

#### **2.3.12 Auxiliary Lanes**

Auxiliary through lanes may be required along sections of any arterial or collector street to address existing or projected capacity or safety issues, at the determination of the City Engineer.



### 2.3.13 Intersections

Intersections shall be designed to provide for the safety of motorists, pedestrians, and bicyclists. Designs shall be based on criteria from the ITE's "Traffic Engineering Handbook" and AASHTO's "Green Book".

#### (1) Basic Intersection Design

By their nature, intersections are conflict locations. Vehicles, pedestrians, and bicycles all cross paths. Each crossing is a conflict point. Intersections contain many conflict points. The basic design of intersections includes the following objectives:

- Minimize points of conflict;
- Simplify areas of conflict;
- Limit conflict frequency; and
- Limit conflict severity.

These objectives can be achieved using the design elements presented as follows.

#### (2) Minimum Number of Intersection Turn Lanes

Intersections planned and constructed in the City shall allow for a minimum number of lanes to provide acceptable levels of traffic operations. **Table 2.3 (6)** identifies the minimum number of turn lanes to be provided at typical arterial, collector and local street intersections. The City Engineer may increase or decrease these requirements based on a traffic impact analysis or other relevant factors.



Typical Intersection of Arterial Streets

**Table 2.3 (6) Typical Minimum Intersection/Interchange Requirements**

Class	Intersecting With A:					
	Major Arterial	Minor Arterial	Major Collector	Minor Collector	High Volume Local	Low Volume Local
<b>Major Arterial</b>	Separate Rights Double Lefts Possible Interchange	Separate Rights Double Lefts Possible Interchange	Separate Rights Double Lefts Possible Interchange	Separate Rights Double Lefts Possible Interchange	Should not connect	Should not connect
<b>Minor Arterial</b>	Separate Rights Double Lefts Possible Interchange	Separate Rights Double Lefts on Arterial	Separate Rights on Arterial Lefts on Collector	Separate Rights on Arterial Lefts on Collector	Should not connect	Should not connect
<b>Major Collector</b>	Separate Rights Double Lefts Possible Interchange	Separate rights Single lefts	Single lefts Possible separate Rights Possible roundabout	Single lefts Possible separate Rights Possible roundabout	Possible Lefts on Collector	Possible Lefts on Collector
<b>Minor Collector</b>	Separate Rights Double Lefts Possible Interchange	Separate rights Single lefts	Single lefts Possible separate Rights Possible roundabout	Single lefts Possible separate Rights Possible roundabout	Possible Lefts on Collector	Possible Lefts on Collector
<b>High Volume Local</b>	Should not connect	Possible Lefts on Arterial	Possible Lefts on Collector Possible roundabout	Possible Lefts on Collector Possible roundabout	Possible roundabout	Possible roundabout
<b>Low Volume Local</b>	Should not connect	Should not connect	Possible Lefts on Collector Possible roundabout	Possible Lefts on Collector Possible roundabout	Possible roundabout	Possible roundabout

### **(3) Location of Intersections**

Intersections create turning movements and therefore conflict points in the traffic stream. It is therefore essential that they be carefully planned, located and designed to function effectively and safely. For intersection location criteria, refer to **Section 2.3.23, Access Management and Design**.

### **(4) Spacing of Intersections**

Intersections with arterial and collector streets shall be as shown on the Major Thoroughfare Plan. When not shown, intersection spacing shall be determined based on a traffic circulation and operations analysis considering elements such as left and right turn lane requirements, traffic weaving movements, location of private access points, and traffic signal coordination. In no case shall these intersections be less than those shown in **Table 2.3 (2)**. Street jogs and/or intersections on local streets of less than two-hundred (200) feet shall not be allowed, except where both intersecting streets are cul-de-sacs in which case the street jogs with centerline offsets of less than one hundred and twenty-five (125) feet shall not be allowed.

### **(5) Lane Alignment**

All lanes shall be in alignment through each intersection, with a maximum of a two (2) foot shift in a hardship situation only, subject to approval by the City Engineer. Should a shift of greater than two (2) feet be allowed, special markings and signs may be required to support that shift design.

### **(6) Angle of Intersection**

Crossing streets shall intersect at ninety (90) degrees whenever possible. In no case shall they intersect at less than eighty (80) degrees or more than one-hundred (100) degrees.

### **(7) Horizontal Alignment and Vertical Profile**

**(a) Horizontal:** The horizontal alignment of streets through an intersection shall be designed in conformance with **Tables 2.3 (2)**. Intersections may be placed on horizontal curves, provided that the tangent lengths given in **Tables 2.3 (2)** are provided on the minor street and the required intersection sight distance is met.

**(b) Vertical:** The street profile grade shall not exceed the percentages shown in **Table 2.3 (5)** for the approaches to the intersection, as measured along the centerline of the street. The profile grade within the intersection streets shall not exceed three (3) percent.

**(c) Prevailing Street Grade:** The grade of the street with the higher classification shall prevail at intersections. The lesser street shall adapt to the grade of the major street. Grading of adjacent property and driveways shall adapt to the street grades. When streets are of equal classification, the City Engineer shall determine which street grade prevails.

### **(8) Exclusive Left Turn Lanes**

Exclusive left turn lanes shall be provided on all arterial streets and other streets wherever left turn lanes are specified as needed by an access plan, required by these Standards or warranted and approved by the City Engineer. The Designer shall use information in the traffic impact study, when available, to determine whether an exclusive left turn lane is warranted on non-arterial streets.

**(a) At Signalized Intersections:** A separate left turn lane shall be required unless otherwise determined by the City Engineer.

**(b) At Unsignalized Intersections:** Left turn lanes may be required at approaches to intersections for which the combination of through, left, and opposing volumes exceeds warrants as stated in a traffic analysis. The City Engineer will determine which peak hours to consider in this evaluation. The traffic impact analysis (TIA) shall make recommendations for the location and dimensions of all left turn lanes.

**(c) Design Criteria:** Left turn lanes shall be designed to provide the following functions:

- i. A means for safe deceleration outside the high speed through lane.
- ii. A storage length long enough for left turning vehicles so that signal phasing can be optimized and intersection delay minimized.
- iii. A means of separating movements at unsignalized intersections to reduce left turn impacts on other flows.

The design elements for a left turn lane are the approach taper, bay taper, lengths of lanes, width of lanes, and departure taper. For a graphical representation of bay taper and approach taper lengths, see **Figure 2.3 (3)**. The required left turn lane widths shall be as specified in **Table 2.3 (1)**. Other dimensions shall be as defined in the traffic impact analysis (TIA).

**(9) Exclusive Right Turn Lanes**

Exclusive right turn lanes shall be provided at locations where they are specified as needed by an access plan, or where required by the applicable traffic impact study, approved by the City Engineer.

**(a) Warrants for Right Turn Lanes:** The traffic impact analysis (TIA) shall determine whether a right turn lane is to be provided at intersections or accesses.

**(b) Design Criteria:** Right turn lanes shall be designed to accomplish the following functions:

- i. Provide a means of safe deceleration outside the high speed through lane.
- ii. Provide a separate storage area for right turns to assist in the optimization of traffic signal phasing.
- iii. Provide a means of separating right turn movements at stop controlled intersections.

The design elements are the approach taper, bay taper, lengths of lanes, width of lanes, and departure taper. For approach taper lengths and other elements, see **Figure 2.3 (4)**.



Pedestrian Refuge

**(c) Pedestrian Refuge:** Where pedestrian refuge is required between a right turn lane and through lanes, it shall be designed in accordance with **Figures 2.3 (5)**.

**(10) Acceleration/Deceleration Lanes**

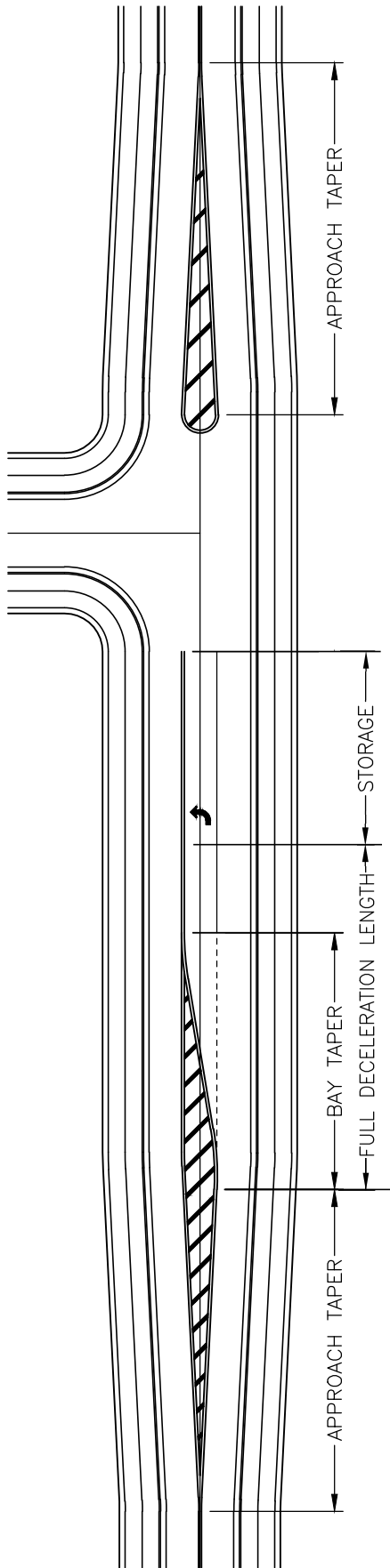
For each high volume driveway and major intersection, acceleration/ deceleration lanes shall be considered. The specific designs for these lanes shall be in accordance with the design for left and right turn lanes given above. *NCHRP Report 279* shall also be consulted during the design process for additional guidance.

**(a) Acceleration Lane Transition Tapers:** The traffic impact analysis (TIA) shall determine the necessary distances for designing acceleration lane lengths and tapers, subject to approval of the City Engineer.

**(b) Deceleration Lane Transition Tapers:** The traffic impact analysis (TIA) shall determine the necessary distances for designing deceleration lane lengths and tapers, subject to approval of the City Engineer.

**(c) Left Turn Approach and Bay Tapers:** When left turn lanes are designed with lateral transitions, the formula on **Figure 2.3 (3)** shall be used to compute the necessary distances, subject to approval of the City Engineer.

**(d) Right Turn Approach and Bay Tapers:** When right turn lanes are designed with lateral transitions, the approach and bay taper formulas on **Figure 2.3 (4)** shall be used to compute the necessary distances, subject to approval of the City Engineer.



- 1) APPROACH TAPER  
 $L = W * S$ , SPEED  $\geq$  45 MPH  
 $L = W * S^2 / 60$ , SPEED  $<$  45 MPH  
 L = LENGTH OF TAPER IN FEET  
 W = WIDTH OF OFFSET IN FEET  
 S = DESIGN SPEED IN MPH

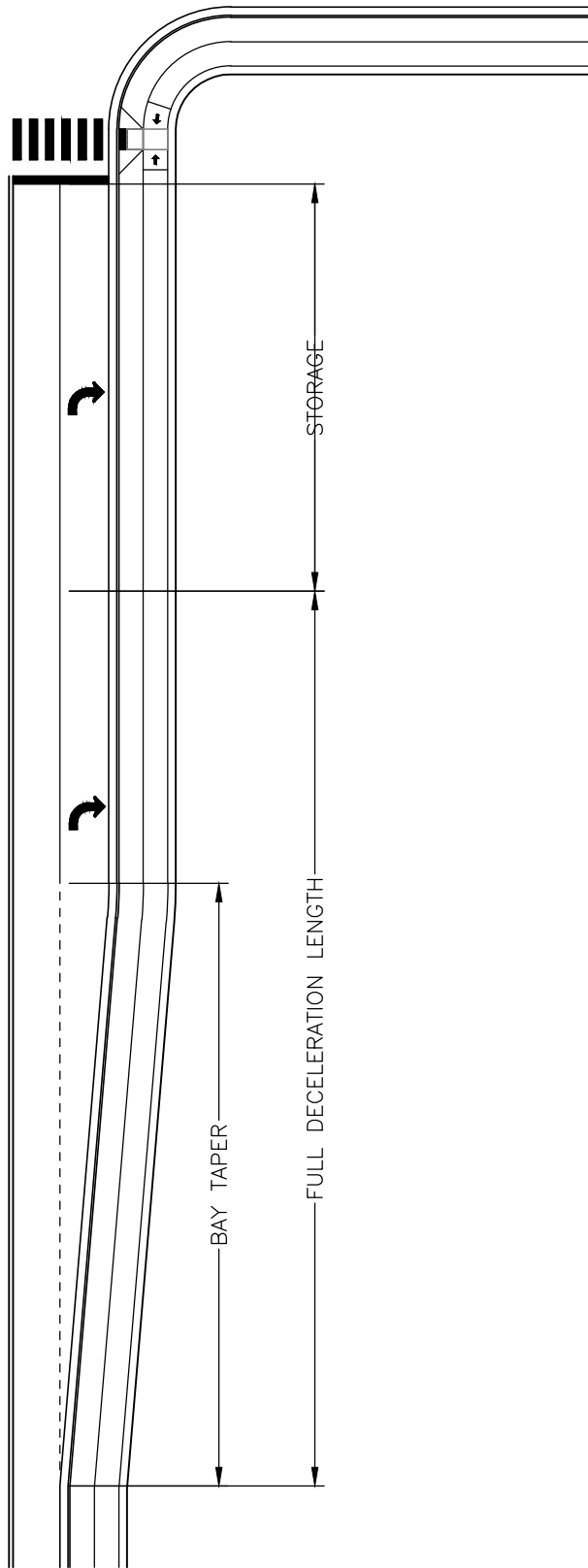
- 2) BAY TAPER  
 $L = WS / 3$

- 3) STORAGE  
 BASED ON TRAFFIC IMPACT STUDY

TAPER TYPE	TAPER RATIOS					
	DESIGN SPEED					
	25	30	35	40	45	50
APPROACH	11:1	15:1	21:1	27:1	45:1	50:1
BAY	9:1	10:1	12:1	14:1	15:1	17:1

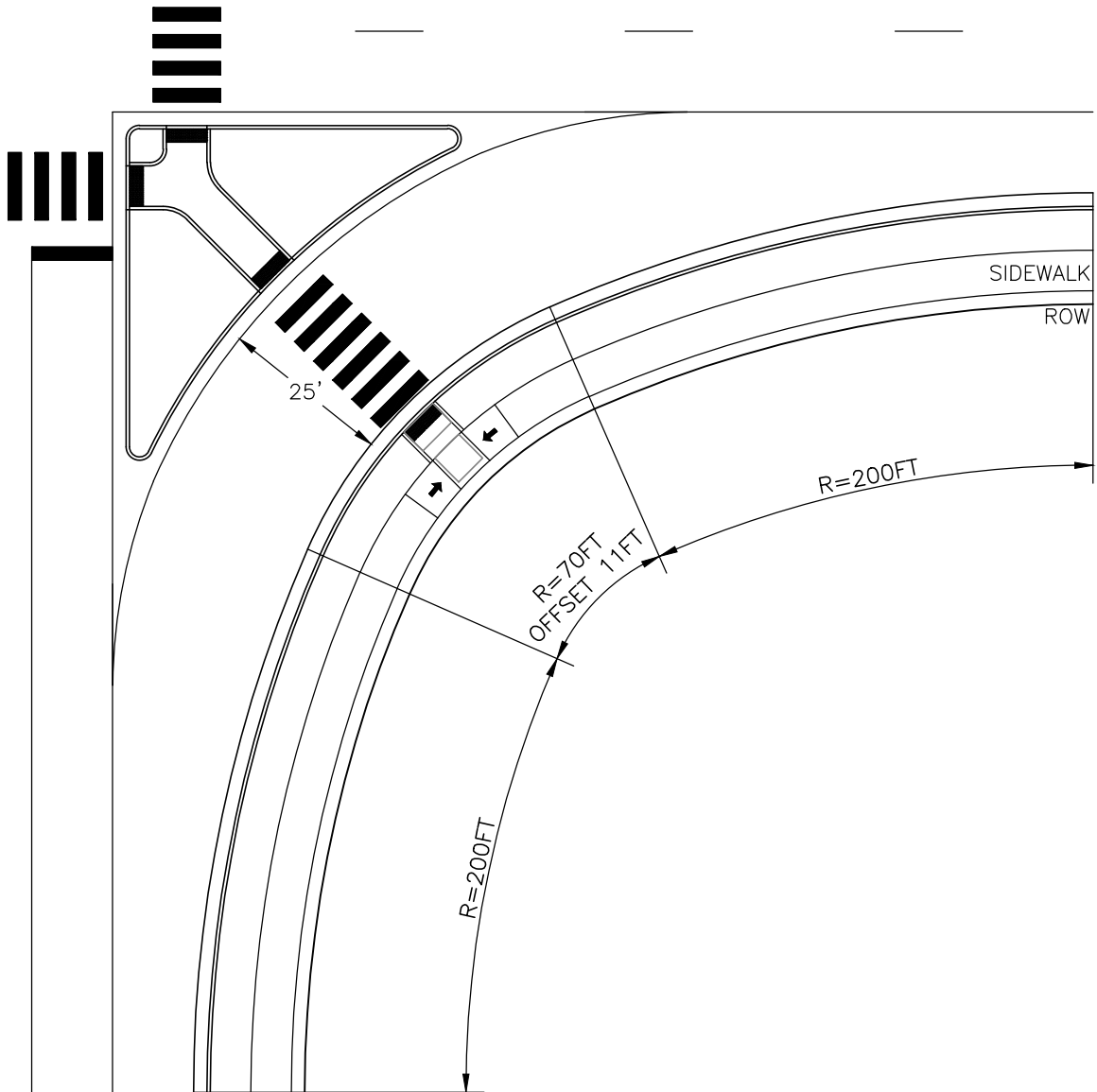


N.T.S  
 LEFT TURN LANE  
 FIGURE 2.3 (3)



N.T.S  
RIGHT TURN LANE  
FIGURE 2.3 (4)





- 1) SEE GREEN BOOK AND TDOT STANDARDS FOR DESIGN OF CORNER ISLANDS.
- 2) REFER TO MUTCD AND TDOT STANDARDS FOR PAVEMENT MARKINGS.
- 3) TURNING RADIUS BASED ON DESIGN VEHICLE AND ROADWAY CLASSIFICATION.



N.T.S  
 PEDESTRIAN REFUGE ISLAND DESIGN WITH CONTINUOUS RIGHT TURN  
 AND THREE-CENTERED CURVE  
 FIGURE 2.3 (5)

**(11) Curb Returns**

**(a) Radii of Curb Returns:** The corner radii at street intersections shall meet the following minimum requirements in **Table 2.3 (7)** unless otherwise approved or required by the City Engineer. For curb returns on a State Highway, TDOT’s curb radii requirements shall supersede these requirements. At street intersections in residential areas, the minimum radius of curb return shall be twenty-five (25) feet. In industrial and commercial areas, and when a residential street intersects with a non-residential street, the minimum curb return radius shall be thirty (30) feet. Should the expected right-turning truck volumes exceed ten (10) vehicles per hour in the design hour, then the designer shall use larger radii or 3-centered compound curves to provide for the turning movements of the larger vehicles. Where the angle of the street intersection is less than ninety (90) degrees, the City Engineer may require greater radii. See **Table 2.3 (3)** for general requirements regarding vehicle turning needs at intersections.

**Table 2.3 (7) Operating Characteristics of Intersection Corner Radii**

Corner Radius	Operational Characteristics
≤ 9	Not appropriate for passenger cars
25-30	Low speed turn for passenger car; crawl-speed for single unit trucks with minor lane encroachment
40	Moderate speed turn for passenger cars. Low speed turn for single unit trucks with minor lane encroachment.
50	Moderate-speed turns for all vehicles up to WB-50

**(b) Curb Return Grades:** The desirable grade for gutter flow-lines around the curb return shall be a minimum of one (1) percent. The minimum allowable grade for gutter flow-lines around curb returns shall be a minimum of one-half (0.5) percent.

**(12) Traffic Islands**

**(a) Corner Islands Separating Right Turns:** Standard corner islands shall be used in four (4) or six (6) lane Arterial/Arterial intersections to channelize traffic where required to provide pedestrian refuge or where required by the City Engineer. The corner islands shall be designed as raised islands in accordance with **Figure 2.3 (5)** and “Green Book” Standards, for a right turn lane continuing to an exclusive lane or for a right turn lane stop or yield condition, respectively. The striping shall be in accordance with the requirements of the Traffic Control Section.

**(b) Median Islands Separating Opposing Traffic:** Median islands are required at all Arterial/Arterial intersections. If raised medians are not required by these Standards, the median islands may be raised or painted. The length of the island shall include the appropriate approach taper, bay taper and length of lane required by these Standards, or supported by another approved resource standard. The design shall be as follows:

- i. No Obstruction. Medians must not obstruct the minimum left turn radius for the design vehicle(s).
- ii. Drainage. Landscaped medians shall include drainage facilities to handle sprinkler run-off and nuisance flows. When low maintenance landscaping is used in conjunction with trickle irrigation, drainage requirements may be waived and outfall curb and gutter shall be used.
- iii. Median Islands Required. Median islands are standard on all new 6-lane and 4-lane Arterial streets. These islands shall be designed to provide pedestrian refuge.



Typical Raised Median

**(c) Median Islands on Minor Arterials, Collectors, or Local Streets:** Raised medians may be placed in Minor Arterial, Collector, and all Local streets. If medians are included, they shall be placed in the public right-of-way, and they must meet the following standards for design:

- i. No Obstruction. The medians may not obstruct the design vehicle turns.
- ii. Visibility. The medians must be placed such that the required visibility in the intersection is not obstructed.
- iii. Undiminished Use. Medians must be placed so they do not diminish the intersection use except where designing a right-in/right-out intersection.
- iv. Median width. Median width shall be sized such as to not create driver confusion or trap sections with intersecting streets.
- v. Alignment. Lanes on one side of the intersection must align with the correct lanes on the opposite side of the intersection.
- vi. Median Maintenance. Most medians will be maintained by parties other than the City. The maintenance responsibility must be defined on the Final Plat or Development Agreement. The City will maintain selected medians, primarily along State highways based on agreements with TDOT.
- vii. Public Use. The City may use these islands for street signing and may choose to remove the medians if it is deemed necessary by the City Engineer.
- viii. Additional Right-of-way. The Developer shall dedicate all additional right-of-way necessary to include these medians.
- ix. Compliance with these Standards. The median design must comply with all applicable median criteria in these Standards and the streetscape standards of the City.

**(d) Turn Prohibition Islands:** An intersection may be designed with islands to prohibit left and right turn movements into or out of the intersection. Typically, these islands should not be used unless there is also a street median present to ensure that improper movements are not made.



Turn Prohibition Island

**e) Splitter Islands on Roundabouts:** In modern roundabout designs, raised splitter islands shall be designed in accordance with the Federal Highway Administration "Roundabouts: An Informational Guide" to direct traffic and provide pedestrian refuge.

### **(13) Right-of-Way**

All intersection rights-of-way and utility easements shall be dedicated to provide adequate right-of-way to include sidewalks, access ramps, and utilities. Additional right-of-way may be required at intersections to provide space for additional left or right turn lanes without reducing the widths of standard required facilities. Where standard intersections are used, additional right-of-way may be required to accommodate the potential installation of a roundabout in the future.

### **(14) Channelization**

Channelization refers to physical or visual guides used to separate vehicles, bicycles and pedestrians into particular lanes.

**(a) Intent of Channelization:**

Channelization is intended to:

- i. Prohibit undesirable or wrong way movements.
- ii. Define desirable vehicular paths.
- iii. Encourage safe vehicle speeds.
- iv. Separate points of conflict wherever possible.
- v. Cause traffic streams to cross at right angles and merge at flat angles.
- vi. Facilitate high-priority traffic movements.
- vii. Facilitate traffic control scheme.
- viii. Remove decelerating, stopped, or slow vehicles from high-speed through-traffic streams.
- ix. Provide safe crossings for pedestrians/bicycles.
- x. Provide safe refuge for pedestrians.



Channelization at intersection

**(b) Specific Channelization Requirements:** Channelization shall be required at locations where it is necessary for safety or to protect the operation of the major street. Examples include:

- i. Providing raised medians in all Arterials where left turns are prohibited.
- ii. Prohibiting undesirable turning movements such as right and left turns, in and/or out.
- iii. Providing exclusive turning lanes, with appropriate striping.
- iv. Providing travel lanes, with widths as specified in the standard street cross sections.
- v. Raised islands must be large enough to be visible to vehicle drivers. Therefore, no single island, including pedestrian paths and/or pedestrian refuge, shall be smaller than 100 square feet.

**(15) Street Narrowing**

Minor Collector or Local streets may be narrowed at intersections to provide more visibility for pedestrians. This shortens the distance necessary for pedestrians to cross the street. The narrowing shall not encroach into bike lanes or travel lanes. Narrowing may not be used on Major Collectors without any parking lanes, on any Arterials, or where the standard width is necessary. When narrowing is proposed, turning paths shall be evaluated to ensure that anticipated service vehicles (fire, sanitation, school buses) can be accommodated with the proposed design.

**(16) Roundabouts**

Roundabouts are considered a form of traffic control. Roundabouts shall be considered as two types: (1) Modern Roundabouts and (2) Mini Roundabouts.

**(a) Modern Roundabouts:** Modern Roundabouts shall be specially designed to the specific need on high traffic volume streets and used to improve traffic flow. Roundabouts shall be designed based on the FHWA's, "*Roundabouts: An Informational Guide*", "*TDOT Standard Specifications*" for typical layout and comply with all "*PROWAG*" requirements.

**(b) Design Experience.** The design shall be performed or checked by a registered Professional Engineer who has designed a minimum of two roundabouts, located on either collector or arterial streets.

(c) **Mini Roundabouts:** Mini Roundabouts may be allowed in a neighborhood setting for traffic calming. Mini roundabouts may be used on Local Streets. The design shall be performed in accordance with the FHWA *Roundabout Design Guide*, or other design criteria approved by the City Engineer.

### 2.3.14 Sidewalks, Curbs & Gutters, Shoulders and Ditches

#### (1) Sidewalks

(a) **Typical Cross-Sections:** Street cross sections that include sidewalks shall be as specified in this chapter and as shown on the Typical Section Drawings.

(b) **Clear Zone:** Sidewalks shall be designed to provide a desirable lateral clear zone of six (6) feet, except when located at back of curb. Vertical clearance shall be at ten (10) feet or higher.



Typical Sidewalk with Grass Strip

(c) **Other Sidewalk Requirements:** Refer to **Section 2.4, Pedestrian Facilities**, and the Franklin Zoning Ordinance for other related sidewalk requirements and guidance.

(d) **Location of Sidewalks:** Sidewalks are required on both sides of all streets in the City except Mack Hatcher Parkway, Interstate 65, heritage roads, alleys and mews. Sidewalk design shall comply with the standards in this section.

(e) **Setback:** Sidewalks shall typically be set back a minimum of six (6) feet behind the street curb. The intervening space between the back of the curb and the edge of the sidewalk is intended for the placement of street trees and other roadside features.

Along nonresidential and mixed-use lots within urban areas, sidewalks may be located at the back of the curb. In no instance shall the intervening space between the back of the curb and the façade of a building be less than twelve (12) feet.

(f) **Minimum Width:** Sidewalks and trails running along streets shall meet the minimum widths as specified in **Table 2.3.1**.

(g) **Ramps:** Ramps meeting requirements of the Americans with Disabilities Act (ADA) shall be installed at the intersection of all sidewalks with public streets. Ramps shall be designed in accordance with the Standard Drawings and shall comply with *Accessibility Guidelines for Pedestrian Facilities in the Public Right-of-Way*.

#### (h) Configuration

- i. Sidewalks shall be constructed of concrete, textured pavers or a combination of these materials, and shall be raised above the adjacent street level. In special circumstances, brick sidewalks may be allowed by the City Engineer, provided that an agreement is executed requiring maintenance by others.
- ii. Pedestrian street crossings at intersections may be raised above the adjacent street level as a traffic-calming measure.
- iii. Sidewalks shall connect with existing or planned sidewalks at property boundaries.
- iv. Sidewalks shall connect building entries within and between developments.
- v. Except where brick or pavers are used, all public sidewalks shall maintain a brushed concrete finish for safety.



vi. Sidewalk intersections with other sidewalks as near to ninety degrees as possible.

**(i) Inlets:** Drainage inlet accesses located in a sidewalk shall be integrated with sidewalks. The inlet access shall be flush with the sidewalk surface. No manholes, inlets, or other storm sewer facilities are allowed within curb ramps. Refer to the drainage study requirements for sizing of inlets. Inlets are not allowed in the curb return, but shall be located at or behind the tangent points of the curb returns.

**(j) Payment In-Lieu of Sidewalks:** See City of Franklin Zoning Ordinance and Municipal Code.

## (2) Curb and Gutter

Type and Location: **Table 2.3 (1)** notes the type of curb and gutter to be used for the various street classifications and sections. See the Standard Drawings for City details for combined curbs and gutters.

**(a) Post Curbs** - Post curb sections without an integral gutter pan shall not be used unless approved by the City Engineer. Under no circumstances will they be used when water flows along the curb face.

**(b) Ribbon Curbs** - Ribbon curb, which is typically 8 inches wide at the top and is cast near the asphalt surface, may be used in locations such as adjacent to medians where surface water runoff is conveyed over the curb to detention areas.

**(c) Standard Combined Curb with Gutters** - The standard vertical face curb and gutter section consists of a 6-inch wide concrete curb cast integral with a 24-inch wide sloping gutter for a combined width of 30 inches. Local streets shall be allowed to use 18-inch wide sloping gutter as approved by the City Engineer.

**(d) Spill Curbs** - Where curb and gutter sections are used in superelevated streets and adjacent to medians, the gutter pan shall be sloped away from the median ("spill curb") to allow sheet flow toward the drainage structures.

**(e) Mountable Curbs** - The standard mountable curb or "rollover" curb is to be cast integral with a 12-inch wide gutter pan for a combined width of 24 inches. Vane grating for mountable curbs requires a width transition of the gutter pan to match the traffic edge of the drain casting.



Vertical combined curb and gutter



Rollover curb with grate transition

## (3) Shoulders

All streets constructed in the City shall be constructed with curb and gutter. However, in extenuating circumstances, shoulders may be allowed by the City Engineer on a case by case interim basis. Where authorized, they shall be provided in addition to the elements shown on the typical cross sections contained at the end of this chapter.

## (4) Roadside Ditches

**(a) Location:** Ditches are not normally allowed in the City unless otherwise approved by the City Engineer.

**(b) Ditch Profile:** The profile grade of the ditch shall be maintained at a minimum slope of one (1.0) percent and a maximum slope of five (5.0) percent. The side slopes of the ditches shall be a minimum of 4:1 and meet any specific criteria of the drainage study. Flatter slopes may be considered when a paved invert is designed for the ditch bottom.

**(c) Ditch Slope:** The slope and capacity of any roadside ditches shall be maintained in any areas that driveways cross the ditch. Each site is required to provide a concrete pipe, a minimum of fifteen (15) inches in diameter, calculated to meet capacity and strength requirements of the drainage study. The pipe shall be designed to have no less than twenty-four (24) inches of cover over the pipe. All portions of the driveway within the right-of-way shall be paved with concrete or asphalt.

**(d) Ditch Maintenance:** All driveway improvements within the right-of-way including piping, ditches, curb and gutter, and sidewalk are generally the responsibility of the City.

### 2.3.15 Medians

#### (1) General Requirements

General criteria for medians are specified in **Table 2.3 (1)**. Also refer to the Franklin Zoning Ordinance. In the City, medians are required on all Arterial and Major Collector Streets. Raised medians are preferred, but depressed or painted medians may be allowed on a case by case basis. Other medians may be required by the City Engineer for specific circumstances to control traffic. Medians requested by developers may be approved as long as additional rights-of-way are dedicated and all maintenance shall be done by viable private parties. The minimum width of any raised median shall be four (4) feet wide, from face-of-curb to face-of-curb.



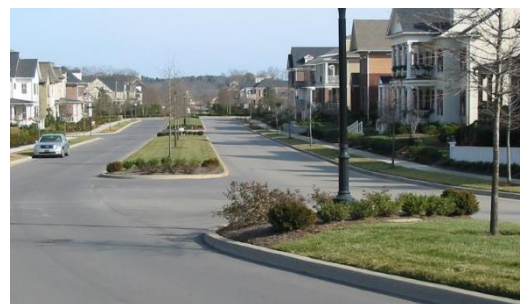
Typical Street Median

#### (2) Turn Lane and Access

The design of medians shall include the evaluation for current and future turn lanes and accesses.

#### (3) Design of Openings

Median openings shall be designed to accommodate the selected design vehicle for all movements. Raised island and other geometric design features shall be installed at median openings when necessary to prohibit certain turning or cross movements in the intersection.



Typical Median Opening

#### (4) Spacing of Openings

The effectiveness of medians is diminished by frequent and/or poorly spaced median openings. Openings should therefore be carefully coordinated with public and private street access points. Median openings shall be located only at major public or private access points, or at midblock locations if needed to serve U-turns. Optimum location of openings is best determined based on the findings of a Traffic Impact Analysis. Minimum spacing on major streets should normally be at least six-hundred (600) feet to accommodate back to back left turn lanes and weaving between openings.

#### (5) Drainage



Landscaped medians shall be provided with drainage facilities to handle sprinkler runoff and nuisance flows. Sprinklers shall be designed to prevent spray onto the pavement surface. A properly designed drain system shall be required.

**(6) Nose Design**

Vehicle tracking templates shall be used to determine the optimum position and design of the median nose so that vehicles do not track onto the median, and are coordinated with other movements in the intersection. The minimum radius for nose curbs shall be two (2) feet to flow-line.

**(7) Paving**

When medians are not landscaped, they shall be paved with stamped, colored, or broom finished concrete in accordance with the City's streetscape standards.

**(8) Transitions**

The ends of medians shall transition into turn lanes with a minimum radius of one-hundred (100) feet. Change in curb directions must be accomplished with the use of radii. Angle points shall not be allowed.

**(9) Objects**

No permanent structures, including light poles, fire hydrants, trees, walls or other fixed objects in the median shall be placed within clear zone as determined by the *Green Book*, or in any location that would obstruct sight distance except for structures as approved in these Standards. All objects placed within the clear zone shall be an approved TDOT/FHWA breakaway design.

**2.3.16 On-Street Parking**

**(1) General**

This chapter defines the parking criteria for on-street parking, including Downtown parking, parking on cul-de-sacs, and other special areas. Parking may be allowed on Local and Minor Collector streets at the discretion of the City Engineer. Parking shall not be allowed on Major Collector and Arterial streets.

**(2) Parallel Parking**

Parallel parking is permitted on certain streets as approved by the City Engineer.

**(3) No Parking Signs**

For all streets in which parking is limited or not allowed, "No Parking" street signs may be required as a part of the street design.

**(4) Non-Parallel Parking**

Diagonal parking shall not be allowed on City public streets and shall not be allowed to utilize the public street for maneuvering. The City Engineer must specifically approve any on-street parking areas that are not designed as parallel parking. All areas approved for diagonal parking shall be designed at an angle of thirty, forty-five, or sixty degrees, as approved by the City Engineer.

**(5) Parking in Cul-de-Sacs**

See **Section 2.3.7(1)**.

**(6) On-Street Accessible Parking Requirements**

Where on-street parking is provided on the block perimeter and the parking is marked or metered, a minimum number of parking spaces must be accessible and shall comply with the *Public Rights-of-Way Accessibility Guidelines*. Where accessible parking spaces are constructed in conjunction with a new street, a 5'-0" wide access aisle, exclusive of the gutter, is required regardless of the parking space location along the block face. Additional right-of-way shall be dedicated as necessary to accommodate the accessible parking space, access aisle, and sidewalk beyond. (**See Figure 2.3 (6)**)

**(7) Inset Parking**

On-street parking shall be inset from the curb line unless otherwise allowed by the City Engineer. In these cases, additional right-of-way will likely be required to provide the roadside features shown on the typical cross sections.



Typical Inset Parking

**(8) Driveway Clearance**

A vehicular parking space within the street shall be designed with a minimum clearance of six (6) feet from the edge of a driveway.

**(9) Intersection Clearance**

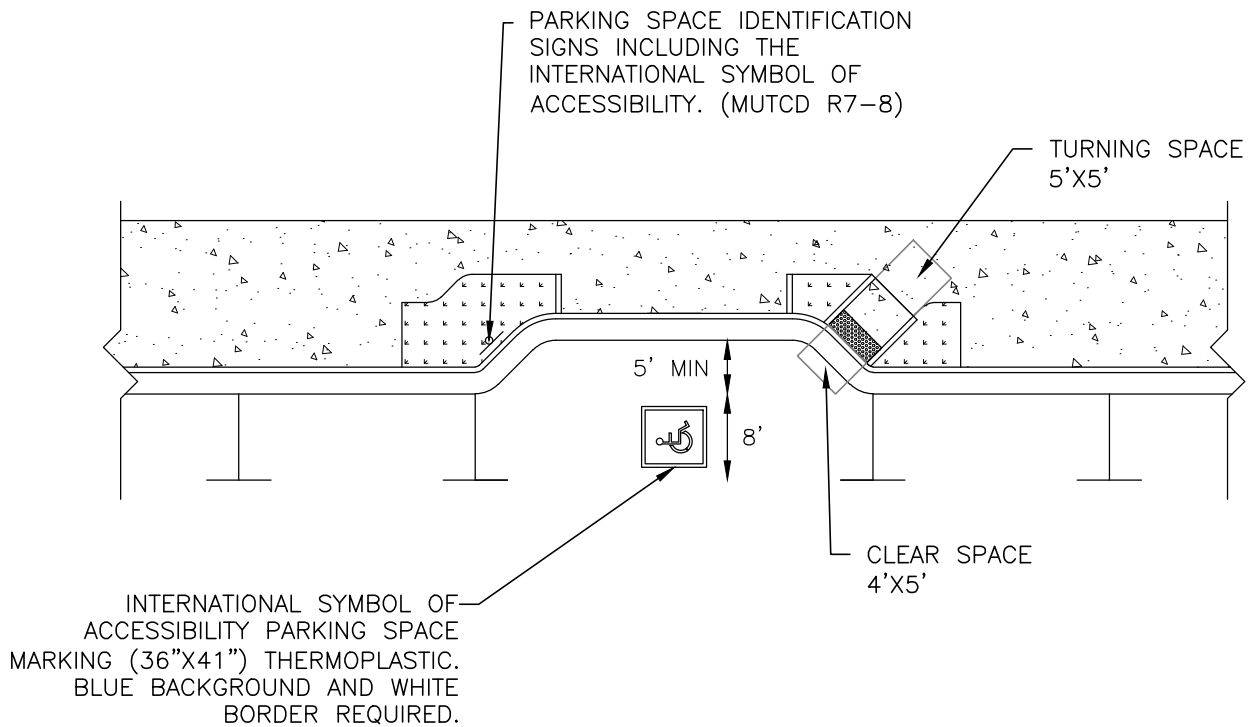
A vehicular parking space in the street shall be designed with a minimum clearance of thirty (30) feet from the intersection flow-line. The designer shall establish the minimum clearance by reviewing sight distance requirements in the *Green Book*.

**(10) Mailboxes**

Special consideration shall be given to mailbox locations near on-street parking such that parked vehicles do not interfere with mail delivery.

**(11) Sidewalks and Trails Adjacent to On-Street Parking**

Sidewalks, trails, and grass strips adjacent to on-street parking shall meet the minimum widths as specified in **Table 2.3.1**. In the rare occurrences where space constraints necessitate the sidewalk or trail to be located immediately adjacent to the on-street parking, the grass strip may be removed subject to the approval of the City Engineer. In these cases, the sidewalk or trail width shall be as specified in **Table 2.3.1**, but not less than 7 feet.



- 1) VEHICLES MAY PARK AT THE CURB OR AT THE PARKING LANE BOUNDARY AND USE THE SPACE REQUIRED ON EITHER THE DRIVER OR PASSENGER SIDE OF THE VEHICLE TO SERVE AS THE ACCESS AISLE.
- 2) SEE PROWAG STANDARDS FOR THE NUMBER OF ACCESSIBLE PARKING SPACES THAT MUST BE PROVIDED ON THE BLOCK PERIMETER WHERE ON-STREET PARKING IS PROVIDED.
- 3) PARKING SPACES MUST BE IDENTIFIED BY SIGNS DISPLAYING THE INTERNATIONAL SYMBOL OF ACCESSIBILITY.
- 4) ACCESSIBLE PARKING SPACES SHOULD BE LOCATED WHERE THE STREET HAS THE LEAST CROWN AND GRADE AND CLOSE TO KEY DESTINATIONS.
- 5) SIDEWALK ADJACENT TO ACCESSIBLE PARALLEL PARKING SPACES SHOULD BE FREE OF SIGNS, STREET FURNITURE, AND OTHER OBSTRUCTIONS TO PERMIT DEPLOYMENT OF VAN SIDE-LIFT OR RAMP OR VEHICLE OCCUPANT TO TRANSFER TO A WHEELCHAIR OR SCOOTER.
- 6) MODIFIED VERSIONS OF THIS DETAIL ARE ALLOWED BUT SHALL COMPLY WITH PROWAG STANDARDS.



N.T.S  
 ACCESSIBLE ON-STREET  
 PARALLEL PARKING SPACE  
 FIGURE 2.3 (6)

### 2.3.17 Bridges

#### (1) Lane and Sidewalk Widths

The width of street travel lanes and sidewalks across bridge structures shall be equal to the widths on the street approaching the structure. Sidewalk and lane widths shall not be reduced from approach dimensions when crossing a bridge structure. Grass strip width may be eliminated across bridges on local streets, however grass strip widths or other means of pedestrian separation approved by the City Engineer shall be provided on collector and arterial streets.

#### (2) Rails

All bridge rail or safety barriers shall be concrete or metal beam guardrail constructed in accordance with approved "TDOT Standard Specifications" as approved by the City Engineer. Concrete parapets shall incorporate aesthetic features such as form liners or stone veneers with a non-sacrificial (i.e. permanent) anti-graffiti coating where required and approved by the City Engineer.

#### (3) Approach End Treatments

All approach end treatments for bridge rails shall be required at each end and shall be in accordance with "TDOT Standard Specifications" as approved by the City Engineer.

### 2.3.18 Clearance Requirements

#### (1) General

Streets shall be designed to minimize the potential for traffic accidents involving fixed objects beside the street travel way. The street designer shall consult the latest edition of the AASHTO "Roadside Design Guide" to design the safest possible roadside along City streets.

#### (2) Horizontal Clearance to Obstructions

The AASHTO "Roadside Design Guide" shall be consulted in the design process to identify the suggested clear zone dimensions and/or barrier for the street being designed. Regardless of this guidance, the desirable minimum lateral clearance from the face of curb to the nearest edge of an object is two (2) feet.

#### (3) Vertical Clearance

The minimum vertical clearance above a street is sixteen feet and six inches.

#### (4) Guardrails

The type and location of guardrails used in the City shall be approved by the City Engineer on a case-by-case basis and comply with TDOT and FHWA standards. Wood Guard rails are prohibited on public and private roadways within the City of Franklin.

### 2.3.19 Barriers and Fencing

#### (1) Roadside Barriers

All safety barriers shall be TDOT/FHWA approved crash-tested barriers. Aesthetic treatments such as stone veneer or concrete with a form liner finish shall be approved by the City Engineer and incorporated in barrier design.



Bridge Rail Barrier

**(2) Median Barriers**

All median divider barriers shall be TDOT approved, crash-tested barriers walls. Glare screens may be required for high volume streets as approved by the City Engineer.

**(3) Fencing**

No fencing shall be installed in the street right-of-way. Fencing installed behind the right-of-way shall not result in sight distance less than the recommended distances in this document.



Access Fencing

**(4) Maintain Sight Distance**

No fencing or barrier installed in or adjacent to the street right-of-way shall result in sight distance less than the recommended distances in this document.

**2.3.20 Provision for Utilities**

This section sets forth the criteria and location requirements for all utilities located within the right-of-way and/or public utility easements located adjacent to public rights-of-way, such as: water, sewer, storm sewer, subdrains, power (electric and natural gas), phone, cable television (CATV), traffic signals and mailboxes. The appropriate utility department or agency shall determine all final alignments of utilities in consultation with the City Engineer. For new and widened streets, provisions shall be made to include conduit for future signal interconnects and all required pull boxes.

**(1) General Requirements**

Standard plan requirements and layout requirements are discussed in earlier sections. Refer to **Figure 2.3 (7)** for general utility placement guidelines.

## (2) Minimum Depth

Utilities shall be located at least thirty-six (36) inches below the finish grade elevation, unless specifically approved to be less by the City Engineer. The minimum depth of cover for storm sewer pipes may be reduced to twenty-four (24) inches to the top of pavement. Greater depth of cover may be specified by the City Engineer.

## (3) Access Covers

**(a) Clearance:** All manhole lids, utility access covers, and range box access covers shall be flush with the street finished surface. If located in concrete drives or sidewalks, all access covers shall be set flush with surrounding concrete.

**(b) Wheel Path:** Manholes or valves installed in the street travel way shall not be designed or constructed in the wheel path of the travel lane or at any location within a bike lane.

## (4) Trees and Large Shrubs

**(a) Buried Utilities:** Trees, berms or large shrubs shall not be placed directly over buried utilities in the public right-of-way or easement. Additional horizontal clearances from the trunk of any tree or shrub to any buried utility may be required by the respective utility department or agency, as required for access, repair and/or maintenance activities.

**(b) Overhead Utilities:** Trees shall not be planted under overhead power lines when mature growth of the tree would encroach within the influence areas of the power lines.

## (5) Use of PVC Sleeves by Franchised and Private Utilities

**(a) General:** It is the intent of these standards to reduce the amount of open cuts in the street. Therefore, franchised and private utility companies shall install all utilities within a non-corrosive sleeve equivalent to Schedule 80 PVC or other sleeves encased in concrete, slurry or flowable fill material, across all public streets to accommodate future repairs without street cuts.

**(b) Exceptions:** Steel gas line street crossings will not require sleeves.

**(c) Depth:** Sleeves shall be installed at a minimum depth of forty-two (42) inches from the top of the pipe to the top of pavement or thirty-six (36) inches from the top of pipe to the top of subgrade, whichever is greater.

**(d) Location:** Unless otherwise approved by the City Engineer, all utility sleeves shall be located within fifteen (15) feet of the parallel gutter flow-line of the existing street and shall be coordinated with other utilities. Sleeves shall be separated for existing buried utilities in accordance with the utility owner requirements. Ten feet of separation is typically preferred.

**(e) Street Cuts:** Utility crossings of existing streets shall be performed in accordance with an approved Street Crossing Permit as issued by the City. Installations utilizing jacking or boring under the street is the primary methods. Open cuts must be justified for need.

**(f) Potential Signalized Intersections:** Refer to **Chapter 8, Signal Design**, for guidance on underground facilities for traffic signals.

## (6) Location Criteria

**(a) General:** The utility locations discussed below are recommended for new development and preferred in the case of existing streets and established developments.



**(b) Water Mains:** Water mains shall be located on the north and east sides of streets approximately seven (7) feet south or west of the north or east gutter flow-line. Water mains shall be separated by a minimum of ten (10) feet horizontally from sanitary sewer and storm sewer facilities. The vertical depth of the water lines shall meet the requirements of the appropriate utility department or agency.

**(c) Fire Hydrants:** Fire hydrants shall be located two (2) feet minimum from curb and gutter flow-line or two (2) feet minimum from back edge of a sidewalk or ten (10) feet minimum from edge of pavement if no curb is present. In addition, the water line shall be located such that the valves will not be in the wheel path of the street lane.

**(d) Sanitary Sewer:** Sanitary sewer shall be on the centerline of the street pavement. If a median is present, the sanitary sewer line shall be located six (6) feet west or south of the median. The sanitary sewer shall be located such that the manhole locations are not within the wheel path of the street lane. The vertical depth of the sanitary sewer lines shall meet the requirements of the sanitary sewer standards of the City.

**(e) Storm Sewer:** The storm sewer shall be placed so the manhole locations are not within the wheel path of the street lane. The storm sewer lines shall meet the requirements of the storm sewer standards as provided in this document.

**(f) Natural Gas:** Gas mains shall be located either within the right-of-way or in an adjacent easement on the south and west sides of the street. For double mains (a main on each side of the street), the requirement of north and east/south and west may be waived by the City Engineer.

**(g) Power and Street Lighting:** Generally, power and street lighting conduits shall be located on both sides of the street either within the right-of-way or in an adjacent easement. Double conduits (a conduit on each side of the street) may be acceptable as approved by the City Engineer.

## **(7) Other Systems**

**(a) Cable TV/Telephone:** Cable TV and telephone lines generally serve properties from the back. For mains along the street front the utility shall coordinate the location in the right-of-way or easements with the City Engineer. All pedestal boxes, new and relocated, located in the right-of-way between the curb and the sidewalk shall be installed below ground.

**(b) Mailboxes:** Mailboxes shall be installed a minimum of one and one-half (1.5) feet from the face of the curb, or travel lane. Mailboxes shall not cause any sight obstruction for motorists exiting side streets or driveways. Mailbox supports shall not pose a fixed object hazard for vehicles and pedestrians.

### **(c) Poles**

- i. Location: Poles, signs, and any other above ground streetscape (except regulatory signs) shall be located within five (5) feet of the right-of-way line or ten (10) feet from the travel lane (flow-line), whichever is most restrictive.
- ii. Clearance: Street light poles shall be placed no closer to the street than two (2) feet behind a vertical curb line and no closer than two (2) feet to any sidewalk.
- iii. Pole Requirements: The City Engineer may require breakaway poles on public right-of-way where speed limit is 40 MPH or higher.
- iv. Engineer Approval: All poles within the public right-of-way must be approved by the City Engineer prior to the permit application for installation.
- v. Other Requirements: All signs and heights shall meet the requirements of **Chapter 8, Traffic Signs and Marking**.

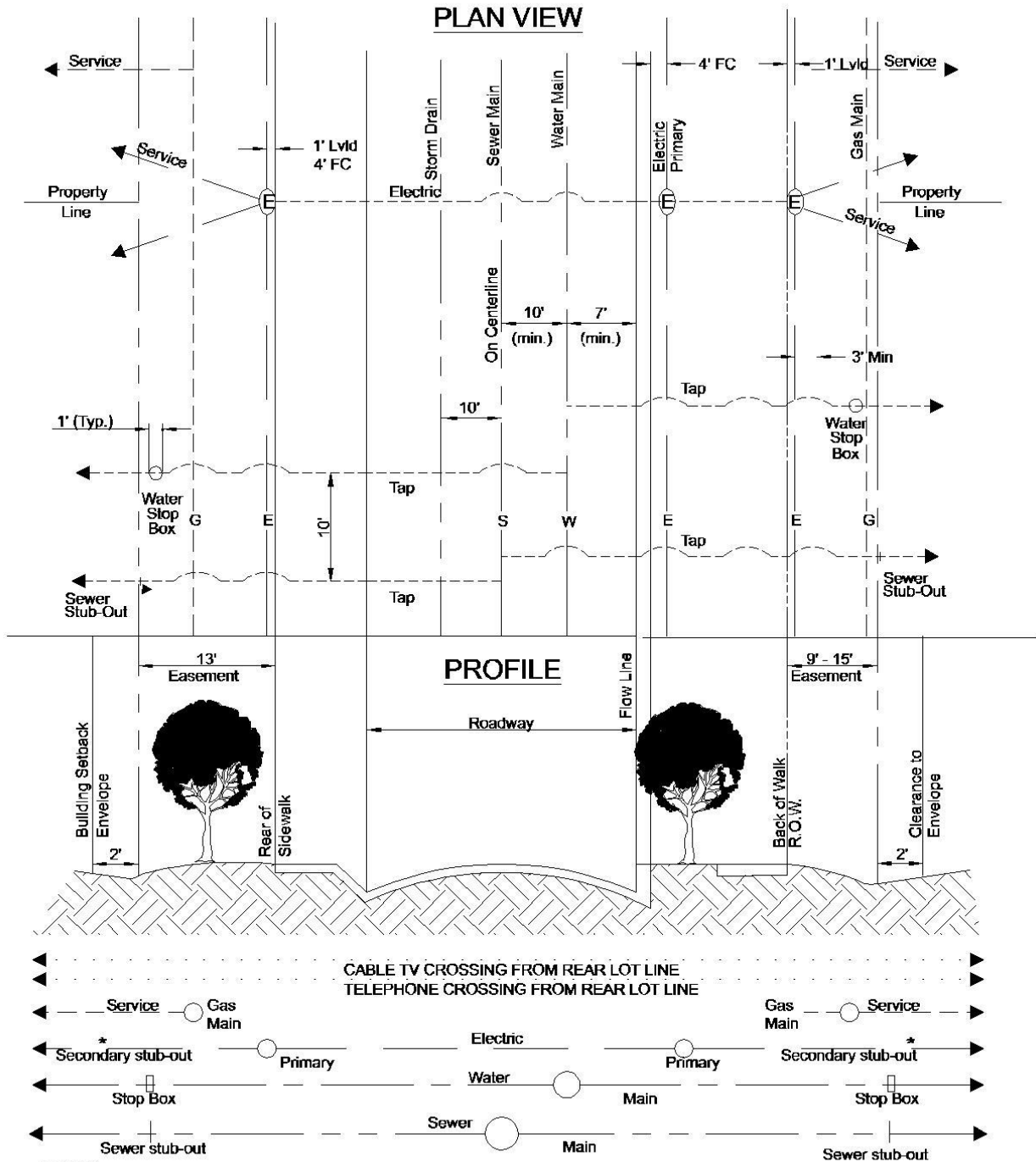


**(d) Subdrains:** Subdrain main lines may be permitted within the public right-of-way. The Developer shall be required to provide additional information and soils investigation. In addition, subdrains shall be designed in accordance with the requirements of this document. If the soils investigation shows that subdrains are required for private property foundations, these lines may be designed to be installed within the public right-of-way only if all requirements of these Standards are met.

- i. Private Property. Subdrains built within the right-of-way for private drainage shall be private improvements and shall have provisions for viable maintenance by the local homeowners association or other private entities. The City may require the private party to abandon or relocate such subdrains.
- ii. Public Property. A subdrain is public if it is used to drain public improvements, such as the street/pavement section.
- iii. Depth. Top of pipe shall be at least thirty-six (36) inches below pavement surface.
- iv. Outlet. All subdrains shall outlet to a detention pond, inlet, or other approved location. Each outlet shall have a device to prohibit backflow into outlet pipe.
- v. Perforated subdrains for private improvements shall not be allowed within any public right-of-way or easement.
- vi. Professional Engineer. Subdrains must be designed by a Professional Engineer and are subject to approval of the City Engineer.

**(8) Utility Crossings with Bridge Structures**

Conduit sleeves may be required within the bridge structures to provide for electrical, gas, telephone, and cable crossings. The City Engineer may require additional sleeves to be designed with the bridge structure for sewer, water, or other utilities.



**NOTES:**

1. No scale to the drawing above. All measurements shown are minimums.
2. Storm and sanitary sewers, manholes, water valves or telephone manholes are not allowed in the wheel path.

**Utility Location Guidelines**  
Figure 2.3 (7)

### **2.3.21 Emergency Access Street Requirements**

Any emergency street access not on public right-of-way shall be provided in accordance with the Franklin Zoning Ordinance and in accordance with the requirements of the City Fire Marshall.

#### **(1) Grade**

The grade of the fire lanes shall be a minimum of one-half (0.5) percent and a maximum of ten (10.0) percent.

#### **(2) Cross Slope**

The Cross Slope of the fire lanes shall be a minimum of one (1.0) percent and a maximum of four (4.0) percent.

#### **(3) Lane Width**

The lane width shall be a minimum of twenty (20) feet from the edge of the street to edge of the street and shall be in an access Easement. The access easement shall have a minimum width of twenty (20) feet. The lane widths may be required to be increased through horizontal curves to accommodate fire truck passage.

#### **(4) Vertical Clearance**

There shall be a minimum of thirteen and one-half (13.5) feet of vertical clearance over the entire fire lane.

#### **(5) Barricade**

The fire lane may contain an approved barricade, but it must be of a type approved by the City Fire Marshall.

#### **(6) Signs and Markings**

The fire lane shall contain signs and markings as required by the City Fire Marshall.

#### **(7) Street Surface**

The surface of the street must be a paved surface complying with Local Street pavement thickness requirements, unless approved otherwise by the City Engineer.

#### **(8) Maintenance**

All access streets shall be maintained and kept clear for emergency use at all times.

### **2.3.22 Bus Stops**

#### **(1) General**

The minimum design criteria for the location and construction of bus stops is as described below. The City Engineer may vary any of the following requirements as deemed appropriate for the site and its particular situation. The Designer shall propose and the City Engineer will approve the exact location of the bus stop in a proposed development. All bus bay locations shall be coordinated with the City Engineer.

Bus stop locations may be required to be constructed with special pavement designs. Developments shall include a trolley shelter along streets served by trolleys at locations identified by the Transit Agency. A statement confirming the viability and availability of the site as a current and/or future trolley stop, and the appropriateness of the design of the shelter, shall be obtained from the agency. If the stop is deemed not viable, then the City Engineer may waive the trolley shelter requirement.

#### **(2) Bus Lane Width**

Bus bays shall be at least ten (10) feet wide.

**(3) Approach Leg (Near-side) Minimum Criteria**

Bus stops on the approach leg of an intersection shall be at least fifty (50) feet long for a single bus, plus a sixty (60) to eighty (80) foot transition distance kept clear approaching the stop.

**(4) Departure Leg (Far-side) Minimum Criteria**

Bus stops on the departure leg of an intersection shall provide a fifty (50) foot long loading area plus forty (40) to sixty (60) feet of transition distance.

**(5) MidBlock Stops**

Midblock stops shall be designed with entrance and exit designed for the posted speed limit in accordance with transition criteria approved by the City Engineer.

**(6) Bus Bays**

All bus pullouts and bays required by the City shall be designed and constructed in accordance with AASHTO guidelines.

**(7) Bus Shelters**

For access and design guidelines for bus shelters required by the City, refer to *AASHTO* guidelines and "*PROWAG*" standards.

**(8) Bus Pullout Lanes**

Bus pullouts shall be constructed with no less than fifty (50) feet between an intersection curb return (point of curvature, P.C.) and the beginning of the lead-in taper.

**2.3.23 Access Management & Design**

**(1) General**

Driveway and street access to the public street system shall be evaluated in the preparation of any plans and Traffic Impact Analysis. The City Engineer may modify any of the requirements of the driveway location and design standards based on trip generation, topography, and/or the anticipated impacts on traffic safety and movement on the street. Notwithstanding any other provisions of these standards, an access, which demonstrates a potential threat or danger to the public and/or which could affect the safe and efficient flow of traffic, may be denied by the City Engineer, based on commonly accepted and applied traffic engineering principles.

**(2) Driveway Design Criteria**

Plans shall provide for compliance with the minimum standards noted below for access from one or more lots to a public street:

**(3) Number of Driveways Permitted**

Access to streets shall be provided to lots either by means of shared access easements, private-drive easements, including frontage or rear access drives, or direct access.

**(a) From Arterial Streets**

- i. Shared-access or private-drive easements shall be used to serve multiple lots. However, when these are unavailable or deemed unnecessary by the City Engineer, then single lots fronting less than six-hundred (600) feet along an arterial street shall have no more than one driveway onto the arterial street.
- ii. Lots fronting between six-hundred (600) feet and twelve-hundred (1,200) feet along an arterial street may have a second driveway, provided that the City Engineer may approve additional driveways based on trip generation or topography.

- iii. Lots fronting in excess of twelve-hundred (1,200) feet along an arterial street may have additional driveways, provided that the City Engineer may approve additional driveways based on trip generation or topography, and it is determined that the impact to traffic safety and movement on the street will be minimal.
- iv. Access to a corner lot fronting on two arterial streets shall be required to have access from the street with the lower average daily traffic volume. Access to a corner lot fronting on an arterial street, and bordered by a collector or local street, shall be required to have access only from the collector or local street. A lot may be permitted to have an additional driveway from the abutting arterial street, provided that the City Engineer may approve additional driveways based on trip generation or topography, and it is determined that the impacts on traffic safety and movement on the street will be minimal. Approval may be conditioned upon other geometric improvements which will mitigate traffic impacts.

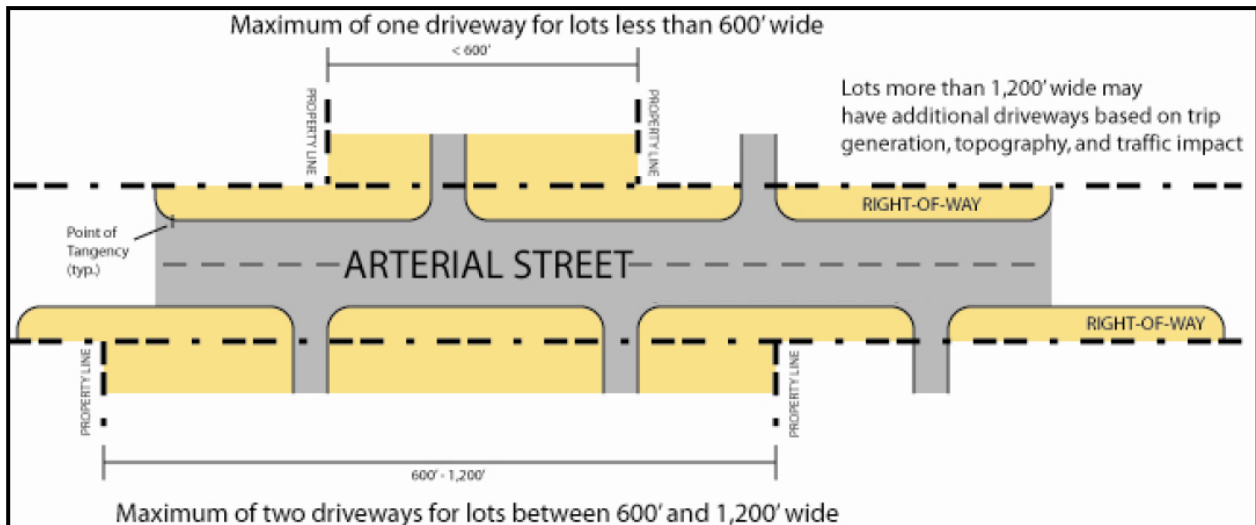


Figure 2.3 (8) – Arterial Street Driveway Spacing Criteria

**(b) From Collector Streets**

- i. Single lots fronting less than three-hundred (300) feet along a collector street shall have no more than one driveway onto the collector street.
- ii. For nonresidential uses, lots fronting more than three-hundred (300) feet along a collector street may have more than one driveway, provided that the City Engineer may approve additional driveways based on trip generation or topography, and it is determined that the impacts on traffic safety and movement on the street will be minimal.
- iii. Access to a corner lot fronting on two collector streets shall be required to have access from the street with the lower average daily traffic volume. Access to a corner lot fronting on a collector street, and bordered by a local street, shall be required to have access only from the local street. A lot may be permitted to have an additional driveway from the abutting collector street, provided that the City Engineer may approve the driveway based on trip generation or topography, and it is determined that the impact on traffic safety and movement on the street will be minimal.
- iv. In general, no access shall be permitted to residential lots from collector streets. However, where no alternative access is available, residential lots with one-hundred and twenty-five (125) feet of frontage or less shall be permitted to have one driveway. Residential lots fronting in excess of one-hundred and twenty-five (125) feet along a collector street may have more than one driveway, provided that the City Engineer may approve an additional driveway only if it will have a minimal impact on traffic safety and movement on the street. Driveways shall be a minimum of fifty (50) feet apart, measured from the nearest point of the radius return of the two driveways.

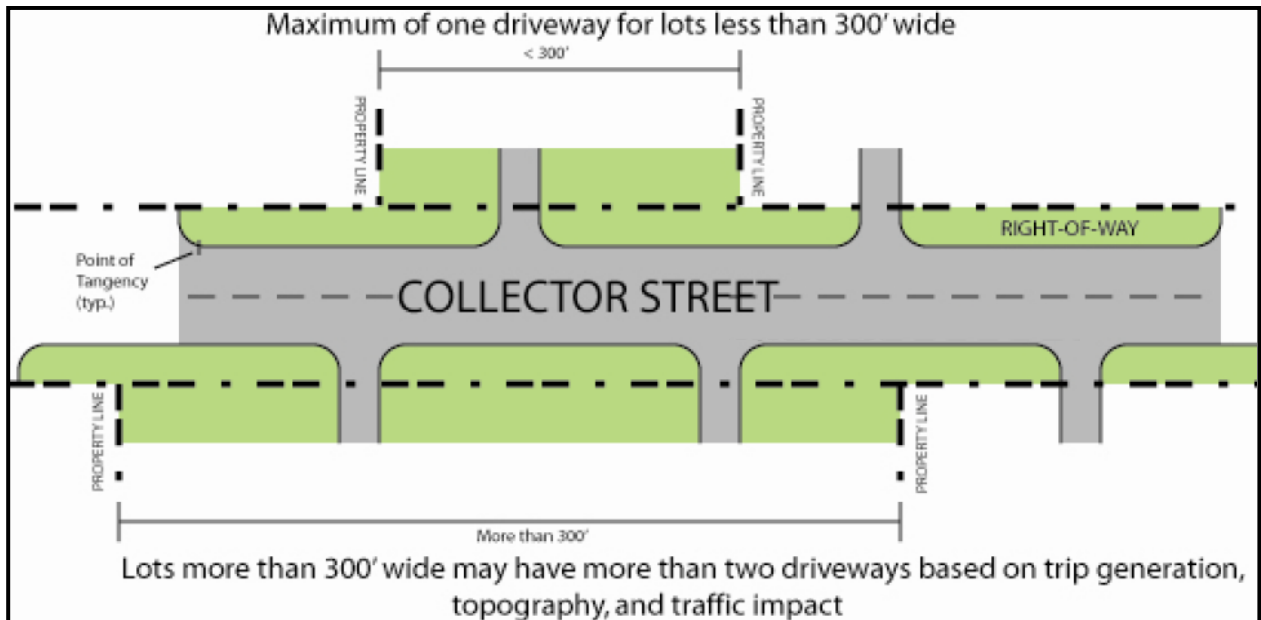


Figure 2.3 (9) – Collector Street Driveway Spacing Criteria

(c) From Local Streets

- i. There shall be no more than one driveway for lots fronting less than one hundred (100) feet along a local street.
- ii. Lots fronting in excess of one-hundred (100) feet along a local street may have more than one driveway, provided that, if approved by the City Engineer for nonresidential uses or the Codes Department for residential uses, the additional driveway will be justified based on trip generation or topography, and it is determined that the impact on traffic safety and movement will be minimal. Driveways shall be a minimum of fifty (50) feet apart, measured from the nearest point of the radius return of the two driveways.

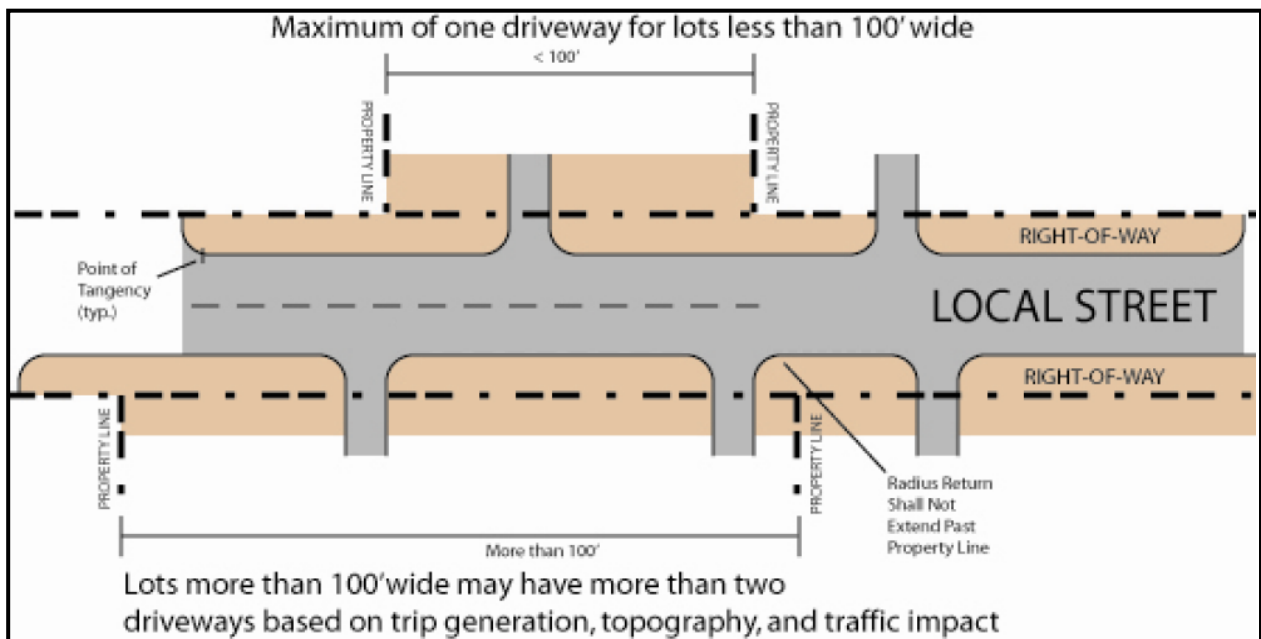


Figure 2.3 (10) – Local Street Driveway Spacing Criteria

#### (4) Minimum Distance from Intersections

(a) No low volume driveway to an arterial street shall be established within two-hundred and fifty (250) feet of an intersecting street. See **Figure 2.3 (11)** for design criteria.

(b) No low volume driveway to a collector street shall be established within two-hundred and thirty (230) feet of an intersecting street. See **Figure 2.3 (12)** for design criteria.

(c) No low volume driveway to a high volume local street shall be established within one-hundred and twenty-five (125) feet of an intersecting street. On low volume local streets, no low volume driveway shall be established within fifty (50) feet of an intersecting street. See **Figure 2.3 (13)** for design criteria.

(d) All distance measurements shall be made from the nearest point of tangency of the curve of the intersecting street right-of-way to the nearest point of radius return of the driveway.

(e) For residential uses, a corner lot abutting two local streets may have a driveway with less than the above required distance from the intersecting street, if, in the opinion of the City Engineer, the driveway will not adversely affect traffic safety and movement on the streets.

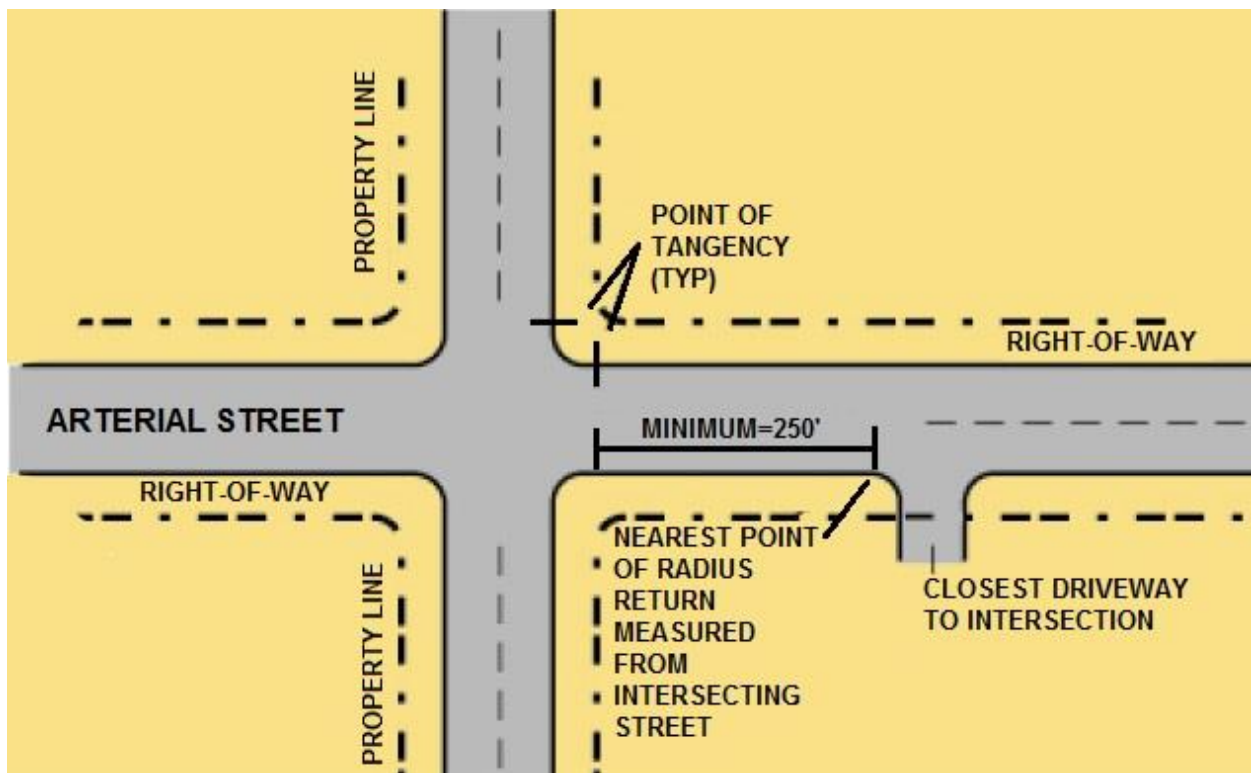


Figure 2.3 (11) – Arterial Street Driveway Intersection Clearance



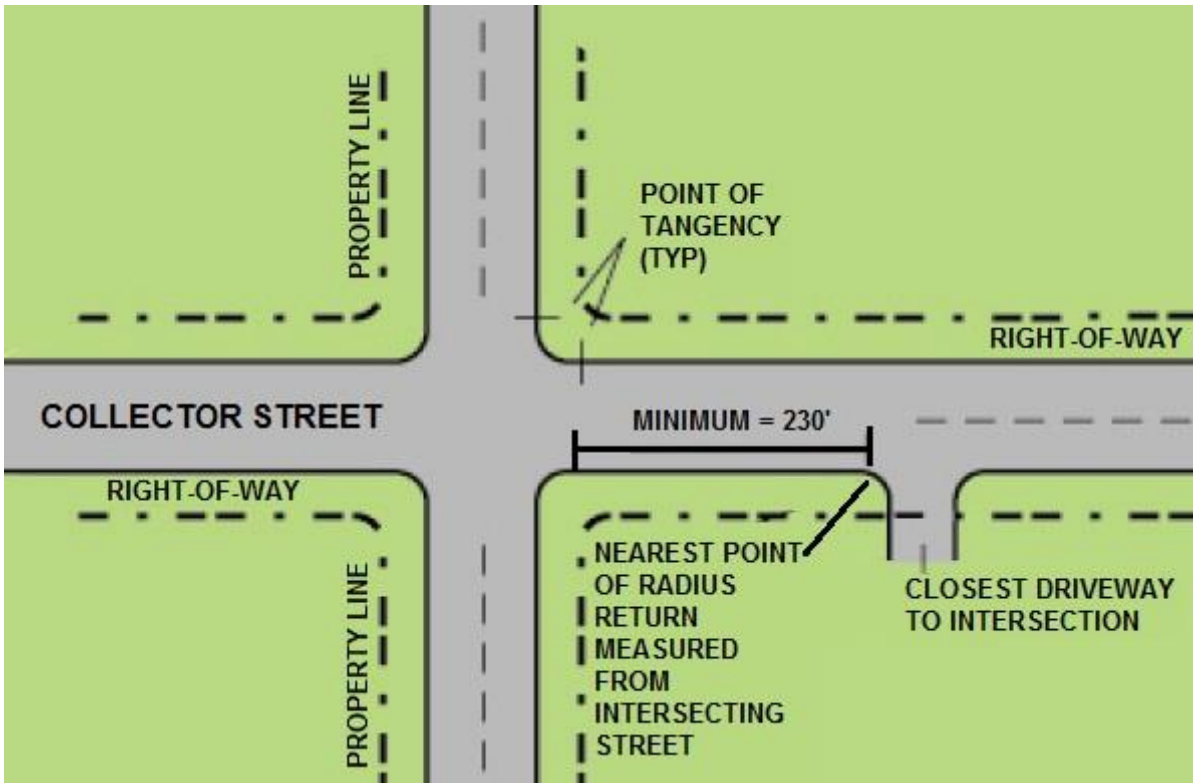


Figure 2.3 (12) – Collector Street Driveway Intersection Clearance

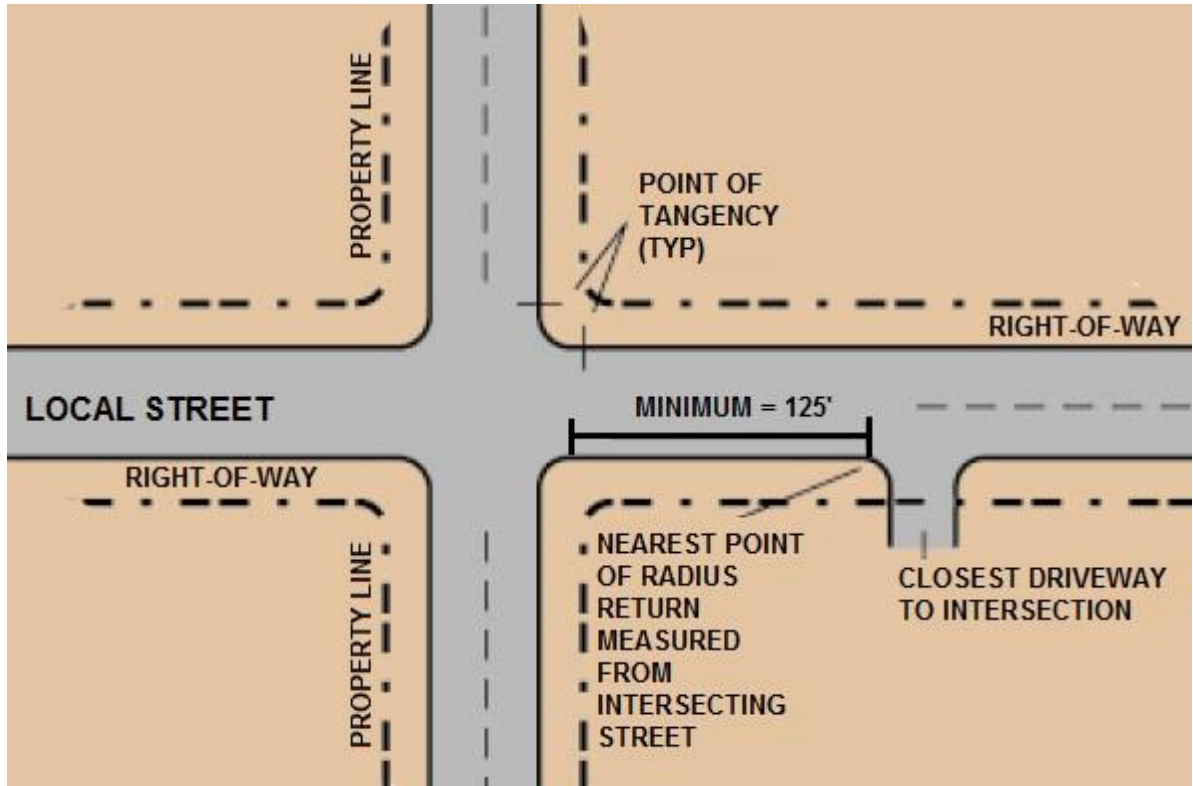


Figure 2.3 (13) Local Street Driveway Intersection Clearance

**(5) Minimum Distance Between Driveways on Separate Lots**

(a) The minimum distance between driveways serving separate lots shall not be less than those shown Table 2.3(2).

(b) The minimum distance may be reduced, provided that, if approved by the City Engineer for nonresidential uses, or Building and Neighborhood Services Department for residential uses, the following conditions exist, based on commonly accepted and applied traffic engineering principles: the use of shared-access or private street easements is not feasible or possible; exceptional topographic constraints or unusual site conditions exist at the driveway location (such as in-place utility or drainage features) which would make strict application of the standard exceptionally and/or practically difficult or unduly harsh; application of this section would conflict with other sections of this ordinance; and where the reduction would not constitute a threat or danger to the safe and efficient flow of traffic.

**(6) Minimum Distance from Property Line**

No driveway, other than a shared-access driveway, shall extend beyond a straight line projection of any side or rear lot line; provided, however, that the provisions may be waived subject to approval by the City Engineer for nonresidential uses or the Codes Department for residential uses.

**(7) Deceleration Lanes**

Approval of a nonresidential use driveway to an arterial or a collector street may be conditioned upon construction of a deceleration lane. The lanes shall be required in conjunction with each driveway to arterial or collector streets where a proposed land use will increase traffic volumes on the existing street to a total in excess of one-thousand (1,000) vehicle trips per day or one-hundred (100) peak-hour vehicle trips per day. The deceleration lane, a minimum of twelve (12) feet wide, measured from the face of the curb for curb sections without a monolithic gutter, the edge of the gutter for a monolithic curb and gutter section, or the edge of the shoulder line for a non-curbed section to the center of the lane line, shall be constructed to City standards with the length measured from the centerline of the driveway according to AASHTO's "Green Book".

**(8) Acceleration Lanes**

In instances of unusual topography or traffic safety considerations, the City Engineer may require the construction of an acceleration lane for nonresidential uses. The length of taper and total length shall be determined based on AASHTO's "Green Book" and other commonly accepted and applied traffic engineering principles.

**(g) Left-Turn Storage Lane**

(a) Approval of a driveway to an arterial street or to a collector street which does not have an exclusive left-turn storage lane may be conditioned upon the construction of a left turn storage lane with appropriate median and/or pavement markings.

(b) The requirement and design of each storage lane, including the paved approach, bay, and departure tapers, shall be based on the recommendations of the traffic study using commonly accepted and applied traffic engineering principles, however final determination of the requirement and design of each storage lane shall be made by the City Engineer. See **Figure 2.3 (3)** for minimum design criteria.

#### **(10) Shared-Access Easements**

- (a) In the re-subdivision of property, the City Engineer may require private driveway easements or other conditions that require multiple lots or parcels to have shared vehicle access locations to arterial or collector streets such as through the use of rear-access or frontage drives where, in accordance with commonly accepted and applied traffic engineering principles, these may be necessary in order to provide for the safe and efficient flow of traffic. Rear-access or frontage drives shall be used only when they can be designed properly to provide safe and efficient access for properties.
- (b) Where shared-access easements are required, the subdivision plat shall state that the transfer of lots shall be subject to the provision of such easements, which shall provide for a guaranteed, unrestricted, right of access to all other owners providing such easements and that the owners of lots subject to shared-access easements shall be required to execute an agreement specifying responsibility for construction and perpetual maintenance of the easements in accordance with the approved access plan. The agreement shall specify that the parties thereto shall hold the City harmless from liabilities resulting from unsafe conditions on shared-access easements.

Copies of the agreements from the current owners of lots through which shared-access easements are to run shall be filed with the City Engineer. Construction on shared-access easements shall not be commenced until all agreements are filed. Copies of all subsequent amendments to the agreements shall also be filed with the City Engineer.

- (c) In the event that the owners fail to maintain shared-access easements in a safe and stable driving condition, the Building and Neighborhood Services Director, after appropriate notice, may have the unsafe or unstable conditions corrected and bill the owners for all reasonable costs. Should the owners fail to pay the City the amount of such charge within thirty (30) days from receipt of a certified invoice, then the costs shall be certified to the City Attorney, who shall process a lien on the properties upon which the expenditure was made.

#### **(11) Driveway Approach Length and Restrictions**

Driveways for nonresidential, multi-family, and other similar uses must extend a minimum of thirty (30) feet into the property from the lot line abutting the street before the edge of the driveway may be intersected by a parking lot space, aisle, or drive. The minimum length of the driveway restriction may be extended, provided that it is determined by the City Engineer that anticipated traffic volumes and commonly accepted and applied traffic engineering principles justify the need for longer, controlled storage lanes. See **Figure 2.3 (14)** for design criteria.

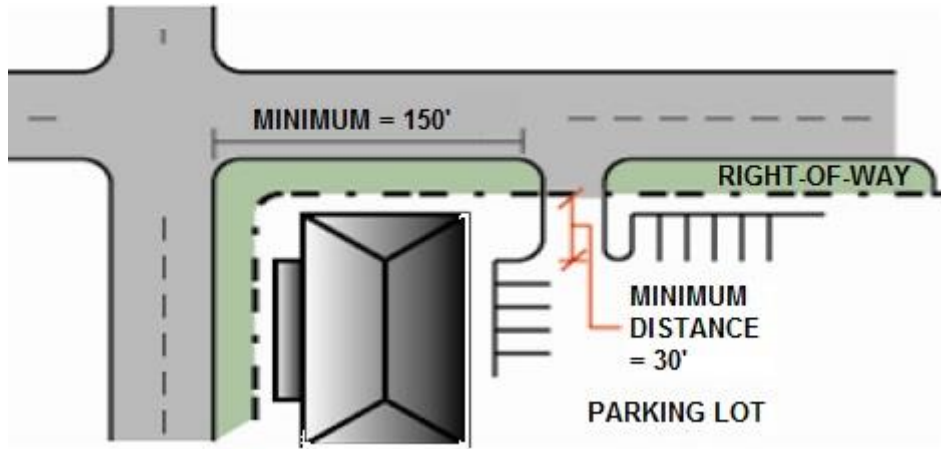


Figure 2.3 (14) – Driveway Approach Design Criteria

**(12) Driveway Width Requirements**

- (a) The width of driveways, measured at the nearest points of the radius returns, shall meet the requirements in the table below.
- (b) Driveways to nonresidential uses may exceed the maximum width, provided that it is determined by the City Engineer that the need to provide safer turning movements and/or the number of trips generated for truck traffic to or from the property will justify the need for additional driveway lanes.

Use	Drive Width (feet)	
	Minimum	Maximum
Residential (to individual dwelling units)	10	20
Nonresidential – One Way Traffic	15	20
Nonresidential – Two Way Traffic <sup>note a</sup>	24	36

NOTE: a. Multilane driveways may be wider subject to the approval of the City Engineer.

**(13) Median Driveways**

Median driveways, in which ingress and egress lanes are separated by a minimum four (4) foot wide raised concrete curb median, may exceed the maximum two-way width, provided that the individual ingress or egress lane will not exceed the limits of one-way access width, and the median will not exceed fourteen (14) feet in width. These dimensions and lanes may be increased for higher-volume driveways if justified by a Traffic Impact Study. Additionally, monuments, walks, vegetation, or signing must not be located in the median in such a way as to interfere with driver vision and safety when entering or exiting the driveway.

**(14) Radius Return at Driveway Entrance**

- (a) The radius return connecting the edge of the acceleration or deceleration lane or through-traffic lane and edge of driveway shall meet the requirements of **Table 2.3 (9)**.
- (b) The radius of the driveway return to nonresidential uses may exceed the maximum radius length, provided that it is determined by the City Engineer that the need to provide safer

turning movements and/or the number of trips generated to or from the property for truck traffic will justify the need for additional radius length.

Table 2.3 (g) Radius Return at Driveway Entrance		
Use	Radius (feet) <sup>1</sup>	
	Minimum	Maximum
Residential	5	15
Nonresidential:		
- Arterial Street	25	40
- Collector Street	25	30
- Local Street	10	25

NOTES: [1] A driveway flare may be used instead of a curve for residential uses.

**(15) Pavement Markings and Signing**

Driveways with more than one ingress or egress lane shall have the pavement surfaced marked with center lines, lane lines, channelization lines, stop lines, and symbol arrows plus traffic control signing in accordance with the requirements of the "MUTCD". The pavement markings and signing shall be continually maintained by the property owner in good condition and visible to drivers at all times.

**(16) Materials**

All driveway areas within the public right-of-way used for vehicular traffic shall be paved with Portland cement concrete (PCC) from the edge of street pavement to the edge of right-of-way or to the back of the sidewalk, whichever is farthest from the curb. PCC may only be required to extend to the back of sidewalk if approved by the City Engineer. In the event a driveway serving a residential use is crossed by a concrete sidewalk, the portion of the driveway from the sidewalk to the flare of the driveway shall utilize the same material and finish as the sidewalk.

**(17) Additional Right-of-Way**

The applicant shall provide or dedicate additional right-of-way and/or easement if it is determined by the City Engineer that the right-of-way and/or easement is necessary for street improvements, such as acceleration/deceleration lanes, as established on the approved access plan.

**(18) Offset from Opposite Streets**

Intersections of streets with Major Arterial streets shall only align with streets intersecting on the opposite side of the Arterial street where a traffic signal or Roundabout will be permitted unless a raised median exists within the Arterial street that restricts the access at the intersections to right-in and right-out turns only. All other intersections must be offset by a minimum of one-hundred and twenty-five (125) feet or greater as required by the City Engineer.

**(19) Avoiding Conflicts in Center Left Turn Lane**

When establishing the placement of offset accesses (either driveways or intersections), ensure that traffic making left-hand turns into the accesses does not conflict or compete for the simultaneous use of a center left turn lane.

**(20) Potential for Future Signalization**

For any driveway access to a Major Arterial, an Access Management Plan and a signal progression plan may be required by the City Engineer. Generally, private direct access is discouraged onto a Major Arterial street to allow the Arterial to better meet its primary function. Public street access to a Major Arterial, where left turns are to be permitted, must meet the signal spacing criteria and the Access Management Plan. Access points that do not meet these requirements shall normally be limited to right turns only, unless they meet the requirements above.

### **(21) Public Street Intersection Spacing**

Local streets should not typically intersect Arterials, but where they do they shall be spaced at a minimum of six-hundred and sixty (660) feet. Full movement access to Major Arterials shall be limited to one-half mile intervals wherever possible, plus or minus approximately two-hundred (200) feet, in order to achieve good speed, capacity, and optimal signal progression. However, to provide flexibility for both existing and future conditions, an approved engineering analysis of signal progression shall be made to properly locate any proposed access that may require signalization.

### **(22) Right Turns Only**

Left turns may be prohibited, allowing right turns only. If left turns are restricted, raised medians will be required to prevent the left turn movements. Access points to arterials will normally be limited to right turns only (through signing and a raised median), unless:

- (a) The access has the potential for signalization, in accordance with the general spacing requirements in this section,
- (b) Left turns would not create unreasonable congestion or safety problems and not appreciably lower the level of service, and
- (c) Alternatives to the left turns would not cause unacceptable traffic operation and safety problems to the general street system.

### **(23) Entrance-Only and Exit-Only Approaches**

Driveway approaches, where the driveway is to serve as either an entrance-only or exit-only drive, shall be appropriately signed by, and at the expense of, the property owner to guide motorists in proper driveway operation. The property owner shall provide whatever means are necessary to ensure that motorists will use the driveway in the intended manner.

### **(24) Profile**

The profile of a driveway approach and the grading of the adjacent area shall be such that when a vehicle is located on the driveway outside the traveled portion of the street the driver can see a sufficient distance in both directions to enter the street without creating a hazardous traffic situation. The driveway profile grade within twenty (20) feet of the flow line shall not exceed eight (8) percent unless a variance is approved by the City Engineer. Driveways within the sidewalk and parkway area of the right-of-way shall slope toward the street. See **Figures 2.3 (15)** for allowable grades and grade breaks for driveway approaches.

### **(25) Adjustments for Existing Structures**

Any adjustments made to utility poles, street light standards, fire hydrants, catch basins or inlets, traffic signs and signals, or other public improvements or installations required for the curb openings or driveways shall be accomplished without cost to the City.

### **(26) Access to Streets with No Curb and Gutter**

Private drive access to Local, Collector, or Arterial streets that have no curb and/or gutter improvements shall be constructed to meet the following requirements:

- (a) **Surface Requirements:** The driveway shall extend from right-of-way line to edge of existing driving surface and shall be constructed based on local street section or concrete driveway per City Standard Drawings.
- (b) **Right-of-Way:** New driveway accesses from private property to existing pavement shall be paved within the right-of-way. On Local rural streets HBP or concrete pavement shall be installed from

the right-of-way line to the edge of the traveled street. The width of the driveway within the right-of-way shall be twelve (12) to twenty-two (22) feet.

- (c) **Culvert:** A culvert shall be installed at the established roadside ditch flow-line elevation beneath the private drive access. The culvert diameter shall be specified by the approved storm drainage report or in absence of the report by the City. A culvert shall be installed in the flow-line of the borrow ditch of a size necessary for the design storm flow (fifteen (15) inch minimum diameter). The pipe shall have flared end sections. The minimum cover over the culvert shall be twenty-four (24) inches. Additional cover may be required for heavy vehicles.
- (d) **Sketch Plan:** A drawing of the proposed driveway installation showing all dimensions shall be submitted with the right-of-way or Access permit application.

**(27) Entrance Angle**

In general, the entrance angle for all driveway approaches and intersections shall be as near ninety degrees (90°) to the centerline of the street as possible. The minimum angle that will be permitted is ninety degrees (90°) plus or minus ten degrees (10°) for a minimum of twenty-five (25) feet measured perpendicular to the street and measuring from the curb or edge of pavement toward the private property served.

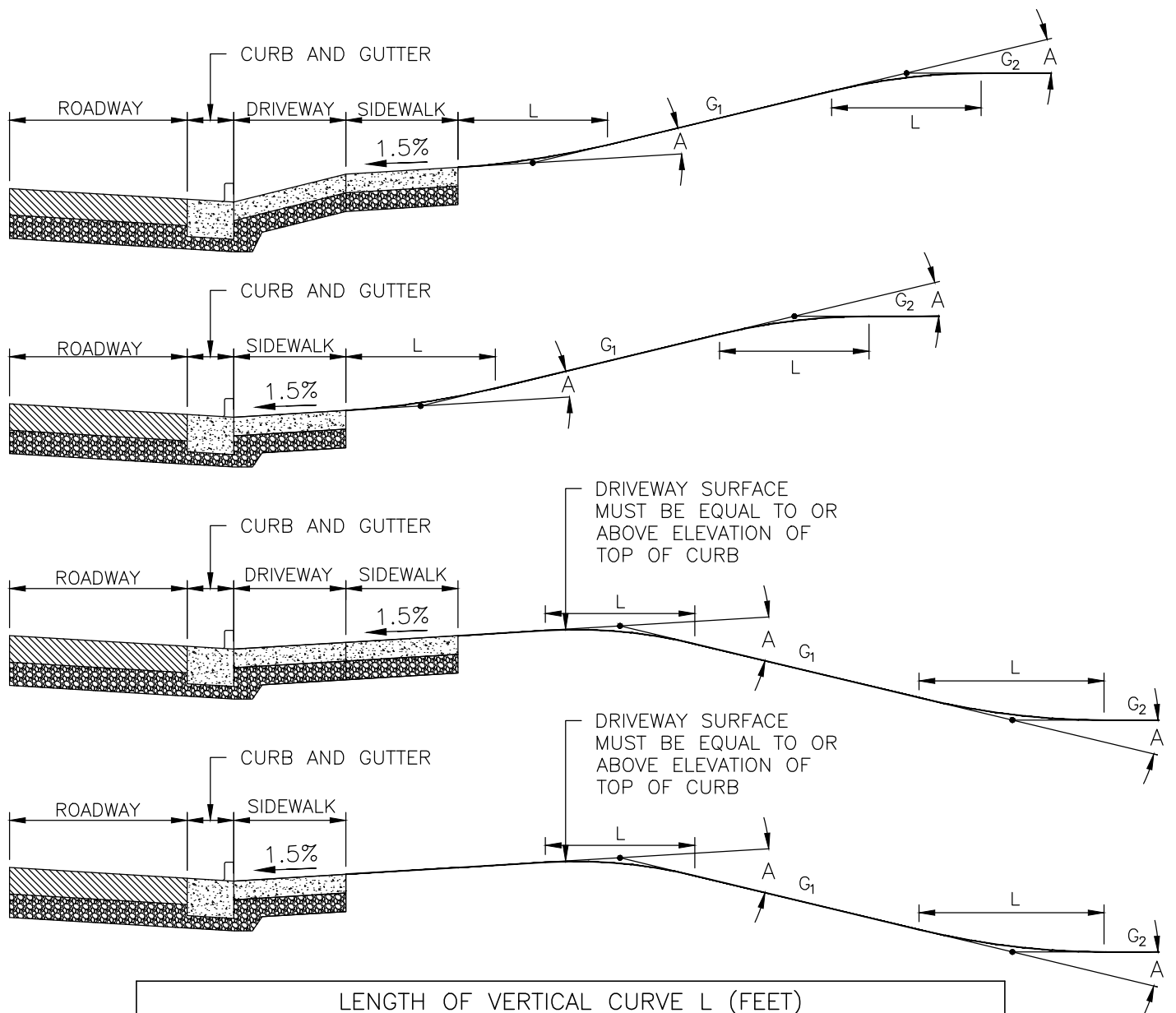
**(28) Access Approaches**

Access approaches shall not be approved for parking or loading areas that require backing maneuvers within the right-of-way except on Local Residential streets. All off-street parking areas on Collector and Arterial streets must include on-site maneuvering areas and aisles to permit user vehicles to enter and exit the site in forward drive.

**(29) Minimum Off-Street Parking Set Back Distance**

Parking maneuvers within a parking lot shall not restrict entering vehicles from safely and efficiently entering the driveway from the public street. The minimum parking setback distance for non-residential driveways is 30 feet from the right-of-way line as described in **Section 2.3.23(11)**. The City Engineer may increase this distance based on a Traffic Impact Study.





LENGTH OF VERTICAL CURVE L (FEET)				
CHANGE IN GRADE, A	CREST MINIMUM LENGTH		SAG MINIMUM LENGTH	
	DESIRABLE	MINIMUM	DESIRABLE	MINIMUM
4-5%	5 Ft	3 Ft	7 Ft	4 Ft
6-7%	6 Ft	4 Ft	8 Ft	5 Ft
8-10%	8 Ft	5 Ft	10 Ft	7 Ft

- 1) GRADES SHALL BE COMPATIBLE WITH THE SITE REQUIREMENTS FOR SIGHT DISTANCE AND DRAINAGE, TO PREVENT EXCESSIVE DRAINAGE RUNOFF FROM ENTERING THE ROADWAY OR ADJACENT PROPERTY.
- 2) MAX CHANGES IN DRIVEWAY GRADES WITH A VERTICAL CURVE (BETWEEN THE PAVEMENT CROSS SLOPE AND THE DRIVEWAY APRON SLOPE) IS 10% FOR PRIVATE RESIDENTIAL DRIVEWAYS AND 8 PERCENT FOR ALL OTHER DRIVEWAYS.
- 3) MAXIMUM DRIVEWAY GRADES SHOULD BE LIMITED TO 8 PERCENT UNLESS APPROVED BY THE CITY ENGINEER. WHERE POSSIBLE, THE DRIVEWAY GRADE SHOULD BE LIMITED TO 6 PERCENT OR LESS WITHIN THE ROADWAY RIGHT-OF-WAY
- 4) THE LENGTH OF THE VERTICAL CURVE BETWEEN THE PAVEMENT CROSS-SLOPE AND THE DRIVEWAY APRON IS A FUNCTION OF THE ALGEBRAIC DIFFERENCE IN THE GRADES. SEE TABLE ABOVE FOR DESIRABLE AND MINIMUM LENGTHS FOR THESE VERTICAL CURVES.



### **(31) Drainage**

- (a) Drainage at Curb Cuts:** Where curb cuts are allowed, concentrated storm water runoff from property adjoining the right-of-way shall not be discharged across the sidewalk. These flows must be directed elsewhere or directed to a sidewalk chase where storm water may pass under a sidewalk section.
  
- (b) Sheet Flow Drainage:** Sheet flow drainage is allowed where it does not interfere with the pedestrian use of the sidewalk

### **(32) Change in Use**

If the use of an existing access to right-of-way changes, or there is a change in the use of the property, the change in access use must be approved through the development review process, access management plan, or traffic impact analysis. Change in access or property use may include, but is not limited to, change in the amount or type of traffic (twenty (20) percent or twenty-five (25) vehicles per hour, whichever is less), structural modifications, remodeling, change in type of business, expansion in existing business, change in zoning, change in property division creating new parcels, etc.

### **(33) Un-permitted Access**

Any access, driveway, or curb-cut which is constructed within public right-of-way without a right-of-way or access permit issued by the City (or State if a State highway) shall be subject to removal. Failure to remove the un-permitted access may result in the removal of said access by the City. The cost for removal shall be charged to the property owner from which the access originates.

### **(34) Abandoned Access**

If a parcel of land with direct access has been in a state of non-use for more than one year, re-commencement of access use shall be considered a change in use. If the use of the access exceeds the design limitations of the access or does not conform with the present code, a new approval may be required through the development plan review process, access management plan, or the City's work in right-of-way permit.

### **(35) Removal**

Any curb opening or driveway that has been abandoned shall be removed and restored by the property owner except where such abandonment has been made at the request of, or for the convenience of, the City.

### **(36) Access Permit Required/Appeals**

- (a)** No curbs or rights-of-way shall be cut, paved, or otherwise altered for the purposes of obtaining access until a permit approving the access cut has been secured from the City and/or any other governmental agency owning or controlling street right-of-way.
  
- (b)** Whenever the City disapproves the location and design of a residential access, or when it is claimed that an equally good or more desirable access plan can be employed, or when it is claimed that the true intent and meaning of these standards have been misconstrued or wrongly interpreted, then the property owner, or his duly authorized agent, may appeal the decision to the City Engineer.

## 2.4 Pedestrian Facilities

All streets shall accommodate pedestrian travel as called for in this chapter

### 2.4.1 ADA Requirements

All pedestrian facilities provided within a City street right-of-way or easement shall be designed to accommodate movement by the disabled as required by the *Accessibility Guidelines for Pedestrian Facilities in the Public Right-of-Way*.

### 2.4.2 Typical Sections

#### (1) Sidewalk Location

The minimum cross sections for sidewalks are provided in **Table 2.3 (1)**, and as shown in the Typical Section Drawings. These cross-sections are consistent with the City's Major Thoroughfare Plan and shall be used to construct sidewalks along both sides of a street. As shown, the cross sections are dependent upon the classification of the street on which they are located. For additional information regarding street classifications and street cross-sections, see **Section 2.2**.

#### (2) Sidewalks on Streets with Ditches

On a street that has ditches instead of curb and gutter; the sidewalk shall be constructed of concrete and be located behind the ditch. Vertical objects shall be placed at least one (1) foot from the sidewalk edge. A one (1) foot wide graded area that has a maximum slope of 6:1 shall be provided on each side of the sidewalk. The grass strip buffer, which contains the ditch and is located between the innermost graded area and the edge of the street, shall be at least twelve (12) feet wide and shall be landscaped with grass. Drainage requirements may dictate an increased ditch section.

### 2.4.3 Managing Access for Pedestrian Safety

Unlimited access creates many points where conflicts may occur between pedestrians and vehicles entering or leaving the street. By restricting the number and size of driveways along a street, many of these potential conflicts can be avoided. Multiple driveways that have multiple lanes and continuous access driveways shall be avoided. When possible, multiple driveways shall be combined. If these driveways serve adjacent properties, cross-access drives between the properties shall be provided in order to eliminate the need for multiple driveways. Continuous access driveways shall be re-designed to create a limited number of entry/exit points. This design shall include grass strips between the street and the parking lot to prevent access at unwanted locations.

### 2.4.4 Intersections

All intersections shall be designed with the assumption that pedestrians will be present. Signalized intersections shall have crosswalks that are clearly marked. They shall also have ramps, landings, pedestrian push buttons, and other pedestrian features that are accessible to everyone. The signing and pavement markings at intersections shall clearly indicate how all street users should operate.

### 2.4.5 Sidewalk Ramps

A sidewalk ramp shall be constructed for each crosswalk at each street corner, as illustrated in the Standard Drawings. In addition to providing the shortest, direct route between sidewalks, this practice makes it easier for pedestrians crossing the street to see right-turning vehicles. If only a single, diagonal sidewalk ramp is provided at a street corner, then right-turning vehicles approach pedestrians crossing the intersecting street from behind. If two perpendicular sidewalk ramps are provided, then right-turning vehicles will approach the pedestrians from the side.

### 2.4.6 Corners

An obstruction-free area shall be provided at street corners between the curbs and a continuation of the adjacent property lines. At a minimum, this distance shall be twenty feet. Only pedestrian push button posts and other pedestrian features shall be located in this area.

## 2.4.7 Crosswalks

### (1) Crosswalk Locations

Crosswalks shall be provided at each stop controlled leg of intersections where significant pedestrian activity is encouraged or exists. Crosswalks across non-stop controlled legs of intersections shall not be allowed. Midblock crossings will be reviewed on a case-by-case basis and per 2.4.7 (3) below. All crossings shall conform to Public Right-of-Way Accessibility Guidelines (PROWAG) guidelines.



Standard Crosswalk

### (2) Crosswalk Markings

Crosswalks shall be clearly marked with a “ladder” pattern, as shown in the Traffic Control chapter, so that they are highly visible to all street users. Crosswalks that are marked with reflective white thermoplastic tape are more visible than those that are marked with brick or cobblestone, especially at night and during rain. Crosswalks that are marked with brick or cobblestone can be made more visible by outlining them with reflective white thermoplastic tape or white concrete outline. Brick and cobblestone are not recommended for crosswalks because these materials can create bumpy paths that are difficult for people with limited mobility to navigate.

### (3) Midblock Crosswalks

Midblock crosswalks shall adhere to the following criteria:

- (a) Midblock pedestrian crossing facilities shall abide by the MUTCD and FHWA “*Guide for Improving Safety at Uncontrolled Crossing Locations*”, July 2018 Updated, with applicable countermeasures per roadway facility type and as approved by the City Engineer (See Table 1 of the “*Guide for Improving Safety at Uncontrolled Crossing Locations*” for recommended countermeasures).
- (b) Midblock pedestrian crossings may be considered when protected intersection crossings are spaced greater than 400 feet or so that crosswalks are located no greater than 200 to 300 feet apart in high pedestrian volume locations. Examples of high volume pedestrian locations include mixed-use pedestrian/bike paths not near a stop controlled intersection, neighborhood pool/park facilities that are located away from a protected intersection crossing, school crossings, parking lots in which pedestrians must cross a roadway to get to an office building, mixed use developments with few stop controlled intersection crossings, etc.
- (c) Midblock crosswalks shall be located at least 125 feet from the nearest side street or driveway so that drivers turning onto the major street have a chance to notice pedestrians and properly yield to pedestrians who are crossing the street.
- (d) Proper stopping sight distance at design speed shall be required. Landscaping or other objects that hides or shields a pedestrian waiting to cross a midblock crossing shall not be allowed.
- (e) Safety street lighting shall be installed on both sides of midblock crossings.
- (f) Advance crosswalk warning signs and/or yield lines may be required by the City Engineer.

#### 2.4.8 Detectable Warning Surfaces

The *Accessibility Guidelines for Pedestrian Facilities in the Public right-of-Way* calls for detectable warnings for pedestrian street crossings, including curb ramps and blended transitions, certain median and refuge islands, and rail lines. These surfaces feature a distinctive pattern of raised domes to provide a tactile cue detectable by cane or underfoot at the boundary between pedestrian and vehicular routes. The City's standard material for installing detectable warnings shall be yellow (ADA Solutions, Inc. or approved Equal) cast in place and shall contrast visually with adjacent walking surfaces either light-on dark or dark-on light. Brick red detectable warnings may be used within existing developments having existing brick red detectable warnings where specifically approved by the City of Franklin Street Department inspector.

#### 2.4.9 Transit Stops

Transit stops shall typically be located at the far side of an intersection. This design encourages pedestrians to cross behind the bus, improving their visibility to oncoming vehicles. A bus stop located on the near side of an intersection blocks the site lines between pedestrians and motorists. The preferred location for a transit stop waiting area is in the buffer strip between the sidewalk and the street. All transit stops shall comply with *Public Rights-of-Way Accessibility Guidelines*.

#### 2.4.10 Grade-Separated Pedestrian Crossings

Grade-separated pedestrian crossings may be warranted across freeway, expressway or arterial streets where the volume of projected vehicular and pedestrian traffic justifies the expense of such a facility. Pedestrian overpasses and underpasses shall be designed based on *Public Rights-of-Way Accessibility Guidelines*. Where the grade separation directs the pedestrians under the street, the subway path shall be substantially illuminated and recessed into the structure.

---

## 2.5 Bicycle Facilities

All streets designed in the City shall accommodate bicycle travel as called for in this chapter of these standards and further defined in the City's Major Thoroughfare Plan (latest edition). Specific streets as outlined in the Plan shall receive the design treatments so designated.

#### 2.5.1 Types of Facilities

A bicycle lane is a travel lane that is between four (4) and six (6) feet wide and that is designated for exclusive use or preferential use by bicyclists. The City standard shall be as shown in **Table 2.3 (1)**. Bicycle lanes are separated from travel lanes with a lane stripe and are identified by pavement markings and signing. These facilities shall be one-way facilities, located on the right side of the street, that carry bicycle traffic in the same direction as the adjacent motor vehicle traffic. Another type of bicycle lane is a shoulder bikeway. A shoulder bikeway is a paved shoulder that is at least five (5) feet wide and that is separated from motor vehicle traffic by a lane stripe. It is also designated by signing. Unlike a bicycle lane, a shoulder bikeway is not designated exclusively for bicyclists. It may serve as a location to temporarily park a damaged vehicle, or it may serve other functions. Typically, shoulder bikeways are applied to rural streets that do not have curb and gutter.



Typical bike lane with signing and markings

#### 2.5.2 Bicycle Shared Streets

A shared street is a street in which motorists and bicyclists share the same travel lanes. There are three types of shared streets. These are:

- Wide outside lane (WOL)
- Signed shared roadway (SSR)

- Local street

(1) A WOL is a travel lane, located on the right side of the street, that is typically fifteen (15) feet wide and that is shared by motorists and bicyclists. The extra width that is provided by a WOL allows motorists to comfortably pass bicyclists without changing lanes and without getting too close to the bicyclists. WOLs are identified by signing and can include pavement markings.

(2) A SSR is a street that is shared by motorists and bicyclists and is identified by signing. Unlike WOLs, SSRs do not provide additional street width for bicyclists. However, they should provide features that make them suitable for bicyclists. These features include traffic control devices that are sensitive to bicyclists, bicycle-safe storm grates, and smooth pavement surfaces. They should also be routinely swept in order to prevent debris from accumulating on the street. Typically, SSRs are reserved for streets that have a high demand for bicycle traffic but cannot accommodate a bicycle lane or WOL due to physical constraints. SSRs should be considered as temporary bicycle facilities and should be replaced by bicycle lanes or WOLs as soon as this is feasible.

(3) Local streets are typically low-speed, low-volume streets. Therefore, they do not usually require special treatment in order to accommodate bicyclists. However, signing may be used to identify a through-bicycle route that follows a local street.

### 2.5.3 Multi-use Paths/Greenways

A multi-use path/greenway is a designated facility that is used for bicycling, walking, running, skating, and other forms of non-motorized travel. It is physically separated from motorized vehicular traffic by a barrier or open space, and can be located within a street right-of-way or an independent right-of-way. Paths/greenways are typically twelve (12) feet wide. They are not part of the street network, but may travel parallel to certain street segments. Also, these facilities may follow the course of natural boundaries, such as rivers and streams, or man-made boundaries, such as railroad lines and utility easements. See Typical Section Drawings.

### 2.5.4 Bicycle Typical Sections

The recommended cross-sections for bicycle lanes, shared streets, and multi-use paths are presented in the Typical Section Drawings. These cross-sections are generally consistent with the recommendations of the City's Major Thoroughfare Plan. In addition to the recommendations contained in this plan, AASHTO's *"Guide for the Development of Bicycle Facilities"* and the *"MUTCD"* shall be consulted in order to determine appropriate pavement markings, signing, etc. for new bicycle facilities.

### 2.5.5 Intersections

Intersections shall be designed so that a bicyclist's path of travel is direct, logical to both bicyclists and motorists, and is as similar to the path of motor vehicle travel as possible. Also, bike lanes shall extend to the stop line/ crosswalk and shall not extend through the pedestrian crossing.

#### (1) T-Intersections

Bike lanes at T-intersections shall be constructed according to the design illustrated in the City's Major Thoroughfare Plan. As shown, left and right turn lanes for bicycles shall be provided unless severe physical constraints prevent the construction of two bicycle turn lanes. If physical constraints do exist, then the bicycle turn lanes can be omitted as long as the vehicular left turn lane is fourteen (14) feet wide. With either design, the bike lane across from the intersection shall be striped through the intersection. However, this bike lane shall not be striped through the crosswalks.

#### (2) Intersections without Exclusive Right Turn Lanes

When a bike lane is present at an intersection that does not have an exclusive right turn lane, the solid bike lane stripe shall be replaced with a dashed line at least fifty (50) feet prior to the stop line/crosswalk.

#### (3) Intersections with Exclusive Right Turn Lanes

At intersections with exclusive right turn lanes, the paths of motorists and cyclists should cross in advance of the intersection in order to reduce the number of conflicts that occur at the intersection. The pavement



markings shall direct bicyclists to the left of the exclusive right turn lane. The bike lane stripes shall be dashed across the area where motorists should cross into the right turn lane. The solid bike lane markings shall resume when the right turn lane achieves full width and shall continue to the stop line/crosswalk. Under severe physical constraints, the bike lane can be terminated if the outermost through lane is fourteen (14) feet wide.

#### **(4) Intersections with Dual Right Turn Lanes**

At an intersection with a right turn lane and a shared through/right turn lane, the bike lane shall terminate at the location where the taper for the right turn lane begins. A dashed line shall be striped between the edge of pavement at the terminus of the bike lane to the lane stripe between the dual right turn lanes. The shared through/right turn lane shall be fourteen (14) feet wide. Also, signing alerting motorists and bicyclists of the approaching lane configuration is recommended.

#### **(5) Complex Intersections**

Intersections of multiple streets and intersections that have offset lanes or skewed streets can create confusion for motorists and bicyclists. When possible, these intersections should be realigned so that the intersecting streets are perpendicular to each other, with only two streets intersecting at a given point. If a complex intersection cannot be avoided, then bike lanes at the intersection shall be defined with a dashed line strip through the intersection. However, the bike lanes shall not be striped through the crosswalks.

---

## **2.6 Traffic Calming**

### **2.6.1 General**

This section presents acceptable methods of neighborhood traffic calming that are determined by the City to be acceptable for use on local streets. This chapter also provides for specific design criteria for a number of traffic calming methods.

#### **(1) Intended Use**

The necessity or desire for traffic safety and calming stems from the perception that local streets, particularly in residential areas, do not always function as intended. These streets shall be low traffic volume streets used for direct access to residences on the street. They are also intended as a multi-modal system that is shared by vehicular, bicycle, and pedestrian traffic equally, in a manner that minimally impacts residents in these areas.

#### **(2) For New Street Design**

The devices presented in this section are generally not intended for use on new streets. New street design is addressed earlier in this section. New local streets are to be designed to minimize cut through traffic, high volumes, and high speed operation and to maximize the efficiency of the street to provide vehicular access and bicycle and pedestrian traffic. Plans prepared for new streets serving residential, nonresidential, and mixed-use development shall comply with the following standards:

(a) Minimal street widths, short block lengths, on-street parking, controlled intersections, roundabouts, and other traffic calming measures shall be used on all local and minor collector streets to the maximum extent practicable.

(b) In cases where residential development has been organized around a grid street network, measures to interrupt or terminate long vistas exceeding twelve-hundred (1,200) feet in length shall be employed to the maximum extent practicable. Such measures shall include, but shall not be limited to:

- i. Curvilinear street segments;
- ii. Street jogs or off-sets designed to require vehicles to slow their travel speed;



- iii. Street chicanes or neck downs;
- iv. Terminated vistas;
- v. Mid-block traffic circles; and
- vi. Stop signs at street intersections, where warranted.

**2.6.2 Traffic Calming Design Criteria**

Reference the City of Franklin Neighborhood Traffic Calming Program (NTCP) on the City of Franklin Engineering webpage for traffic calming requirements.

**2.6.3 Traffic Calming Techniques**

**(1) Approved Techniques**

There are a variety of techniques that can be used to calm traffic on local, residential streets. Techniques that are specifically permitted, as well as techniques that are specifically prohibited, in the City are described below. Techniques that are specifically permitted are summarized in the following table, which also identifies the potential benefits and disadvantages of each.

**Table 2.6 (1)**

**POTENTIAL IMPACTS OF TRAFFIC CALMING TECHNIQUES THAT MAY BE USED IN THE CITY OF FRANKLIN**

Measure	Potential Benefits			Potential Disadvantages			Cost
	Speed Reduction	Volume Reduction	Conflict Reduction	Limits Local Access	Increases Emergency Response Time	Extent of Maintenance Required	
Chicane	●	●	●	○	⊙	⊙	\$\$\$-\$\$\$\$
Curb Extension	⊙	○	○	○	○	⊙	\$-\$\$
Education	⊙	○	⊙	○	○	○	\$
Enforcement	⊙	○	⊙	○	○	○	\$-\$\$
Lower Speed Limit	⊙	○	○	○	○	○	\$
Raised Median	⊙	○	⊙	⊙	○	⊙	\$-\$\$
Road Diet	⊙	○	⊙	○	○	○	\$-\$\$\$
Speed Table/Hump	●	⊙	●	○	⊙	⊙	\$-\$\$
Traffic Circle	●	⊙	●	○	⊙	⊙	\$\$\$-\$\$\$\$

● Substantial Benefits/Disadvantages  
\$ Low Cost

⊙ Minor Benefits/Disadvantages  
\$\$ Moderate Cost

○ No Benefits/Disadvantages  
\$\$\$ High Cost

**(a) Chicane:** A chicane shifts motorists’ path of travel by creating a horizontal diversion in the roadway. A chicane is usually formed by a series of curb extensions that are placed on alternating sides of the roadway. These curb extensions reduce the roadway width and force motorists to steer from one side of the roadway to the other in order to travel through the chicane. See **Figure 2.6 (2)** for a typical drawing of this technique.

**(b) Curb Extensions:** Curb extensions are formed by extending the curb on one or both sides of the roadway into the vehicular travel lanes to reduce the paved roadway width. The reduction in width creates “slow points” in traffic flow. Curb extensions are also commonly referred to as chokers, neck downs, traffic throats, and pedestrian bulbs. Curb extensions reduce the width of the roadway at intersections and create shorter crossing distances for pedestrians. The reduction in lane width encourages motorists to slow down when driving through the intersection. See **Figure 2.6 (3)** and **Figure 2.6 (4)** for a typical drawing of this technique.

**(c) Education:** Education is a key component of all traffic calming projects in the City. Before implementing physical traffic calming measures, the City Engineer will work with participating neighborhoods to educate their residents regarding safe, on-street, vehicular travel. The City Engineer will assist the neighborhood associations/groups in developing educational programs for the residents. However, it will be the responsibility of the neighborhood associations/groups to implement the educational programs.

**(d) Enforcement:** Enforcement efforts will be combined with neighborhood education as a first step in all traffic calming projects in the City. The Police Department will work with the City Engineer to help resolve traffic problems, such as speeding. Enforcement efforts may involve the use of speed trailers and may include tickets for violators.

**(e) Lower Speed Limits:** Establishing lower speed limits may help to reduce speeding and cut-through traffic in residential neighborhoods. Some local, residential roadways have speed limits that are posted at 30 MPH or more. It may be desirable to lower the speed limits on these roadways to the City's default speed limit, which is 25 MPH for local, residential streets.

**(f) Raised Median:** A raised median is an elevated island that is constructed on the centerline of a two-way street to reduce the width of the adjacent travel lanes. Raised medians can be paved or landscaped. They create "slow points" in the roadway, can serve as pedestrian refuges for pedestrians crossing the street, and can be used in conjunction with other traffic calming measures. See **Figure 2.6(5)** for a typical drawing of this technique.

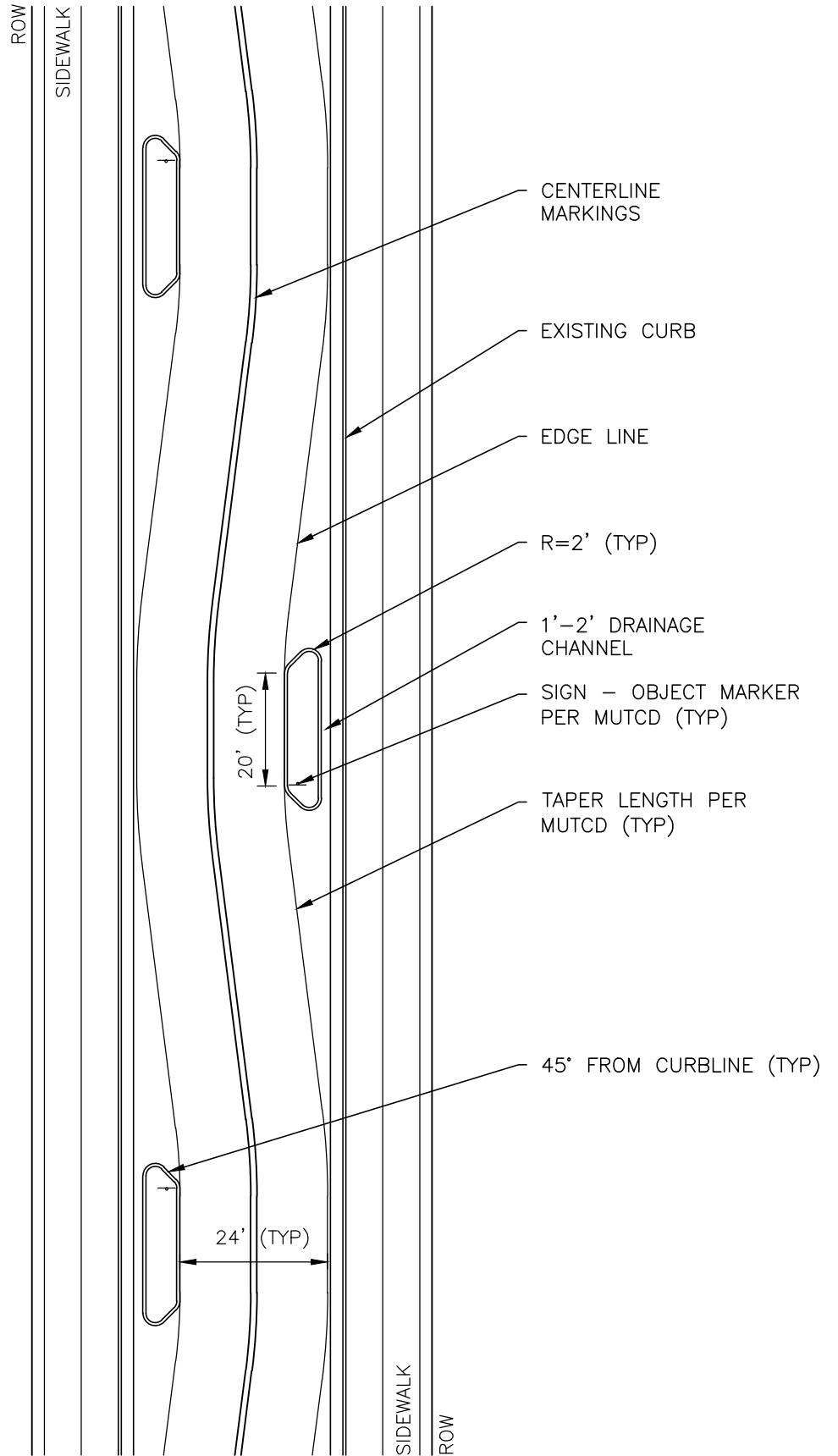
**(g) Travel Lane Reduction:** Reducing the number of travel lanes, or the width of travel lanes, on a roadway can be an effective technique for calming traffic on that street. This process, called a "road diet", can help to reduce vehicular speeds, reduce the number of conflict points for right-of-way users, and can help make streets more bicycle and pedestrian-friendly. Road diets can be accomplished by adding parking lanes, adding bike lanes, adding a median, or by reclaiming some of the roadway width, which can create room for sidewalks and street trees.

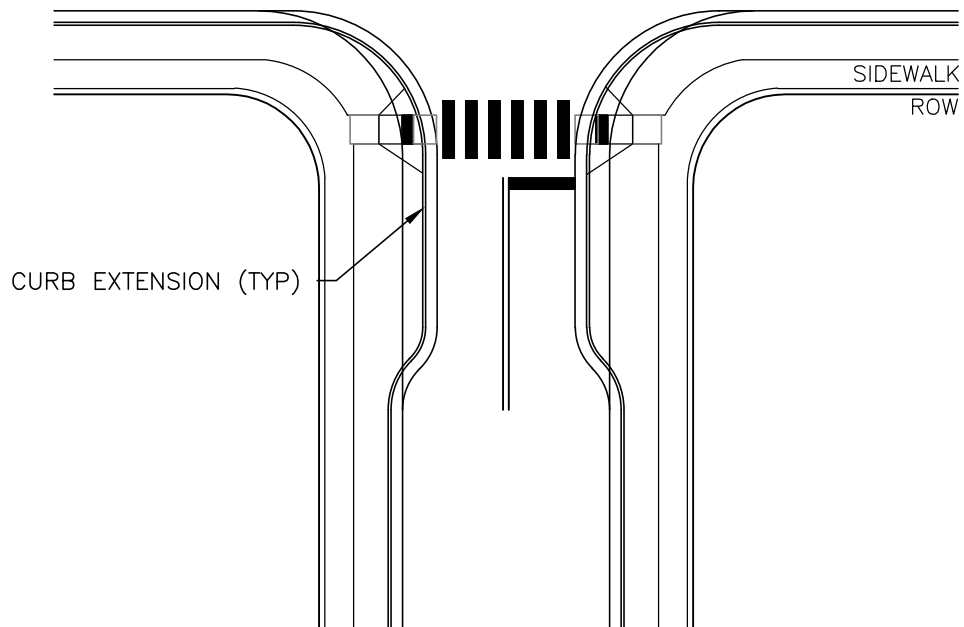
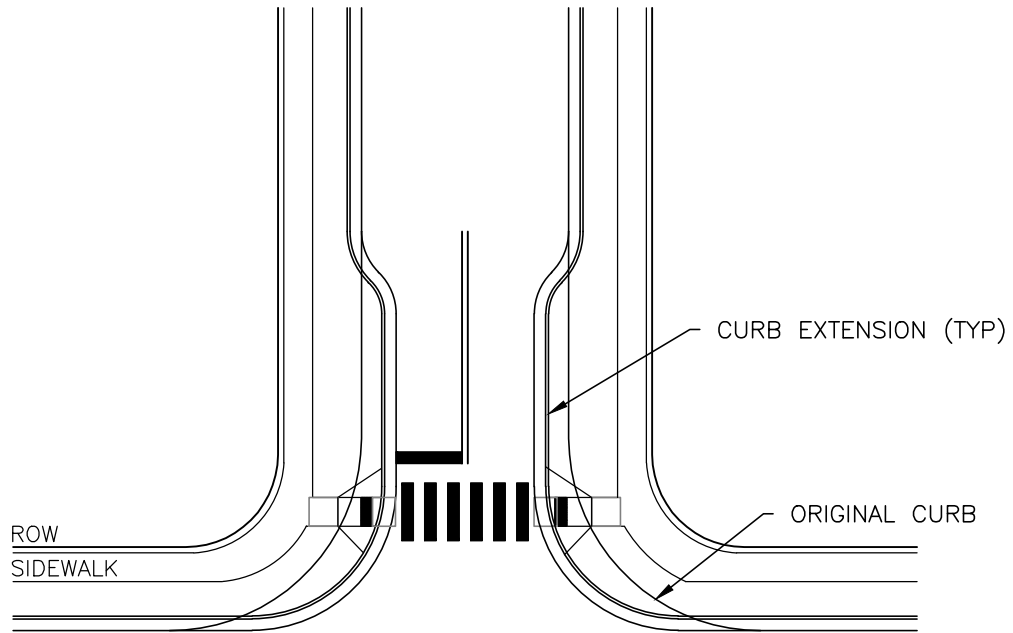
**(h) Speed Table/Hump:** A speed table/hump is a wide and flat undulation that is placed on a street, typically across the width of the roadway, to reduce vehicular speeds. They have a height of three (3) to four (4) inches and a length of twelve (12) or twenty-two (22) feet. Speed humps shall be distinguished from speed bumps, which are much shorter (six to twelve inches long) and have been associated with maintenance, safety, and liability concerns. The speed table/hump that may be used in the City is twenty-two (22) feet long and three (three) inches high. See **Figure 2.6 (6)** for a typical drawing of this technique.

**(i) Traffic Circle:** A traffic circle is a raised, circular island that is typically placed in the center of a residential street intersection to allow traffic to flow through the intersection without being controlled by a stop sign or a traffic signal. The design of a traffic circle requires motorists to travel through the intersection in a counter-clockwise direction around the island, which reduces the number of conflict points and reduces vehicular speeds. A traffic circle creates a horizontal deflection in the roadway, which causes motorists to slow down as they travel through the intersection. See **Figure 2.6 (7)** for a typical drawing of this technique.

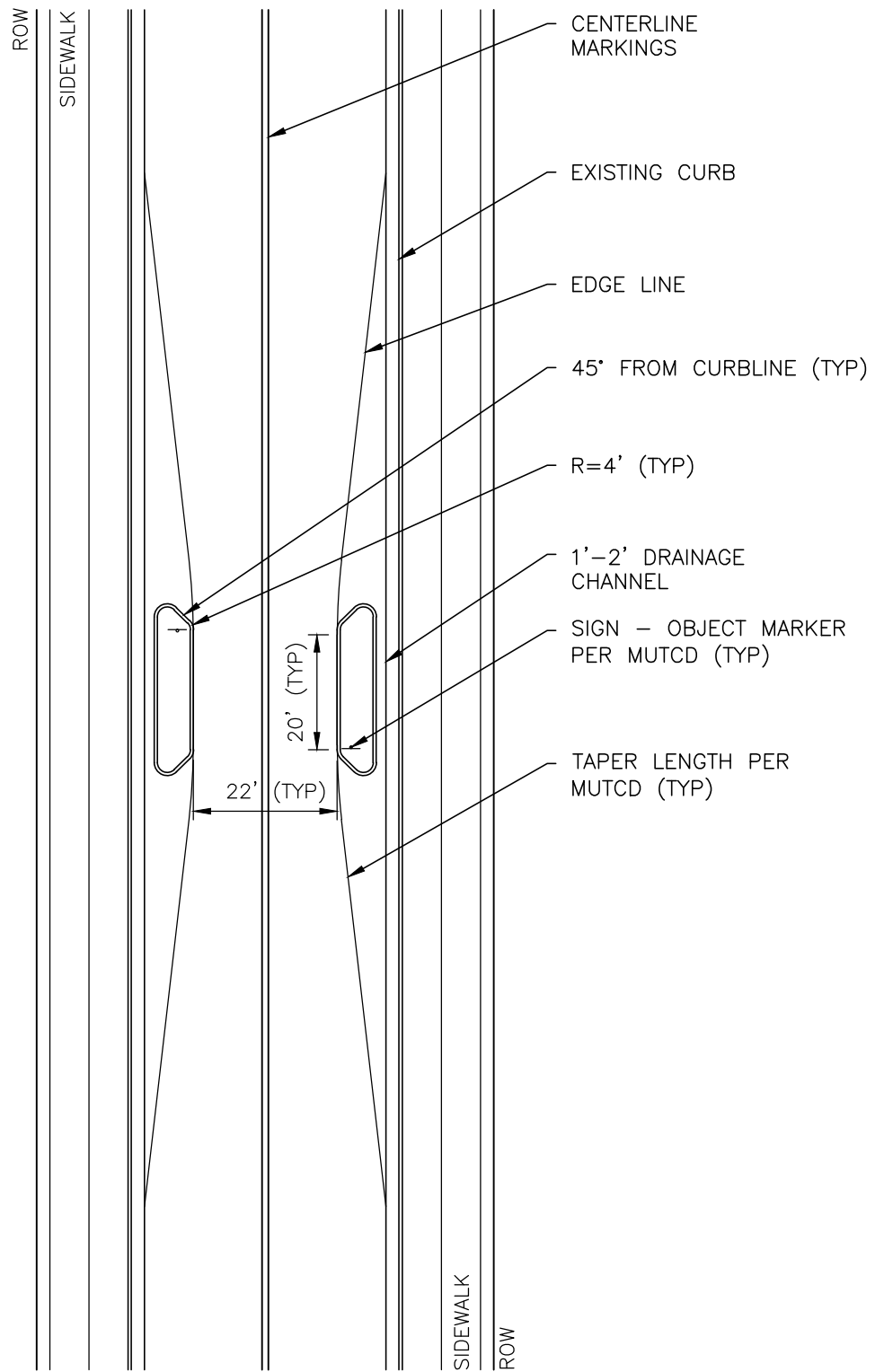
## **(2) Prohibited Techniques**

**(a) Rumble Strips:** Rumble strips are raised buttons, bars, or groves that are closely placed on a roadway at regular intervals. They cause both noise and vibration in vehicles as motorists drive over them. Typically, rumble strips are used to alert motorists of unusual conditions ahead. As motorists get used to the rumble strips, the strips become less effective over time. Rumble strips can result in increased noise levels for nearby residents. Also, rumble strips require a high amount of maintenance. For these reasons, rumble strips shall not be used as a traffic calming technique in the City.

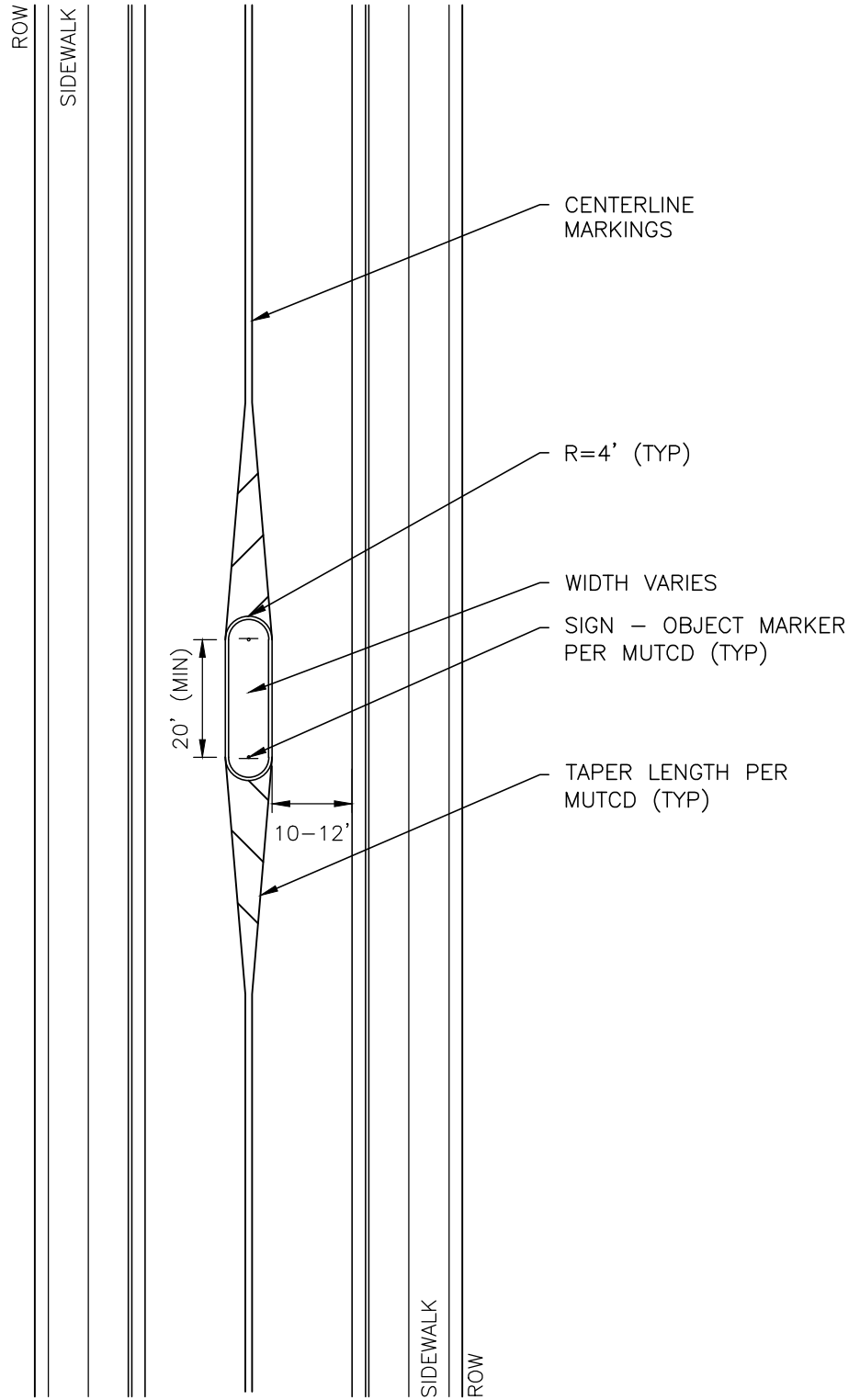




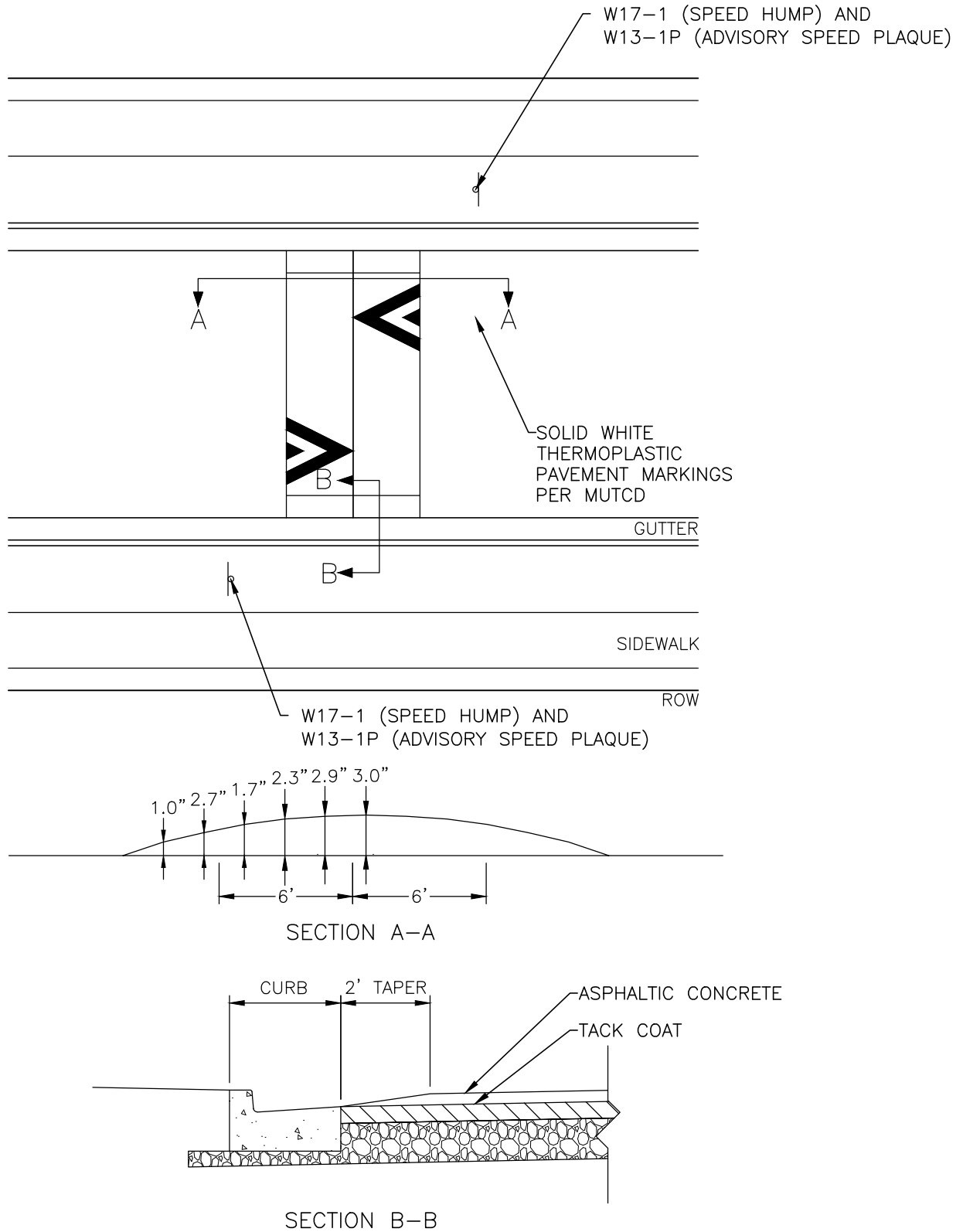
- 1) INTERSECTION RADII SHOULD ACCOMMODATE DESIGN VEHICLES APPLICABLE TO STREET.
- 2) MID-BLOCK CURB EXTENSIONS SHOULD BE COMBINED WITH CROSSWALKS WHERE POSSIBLE.
- 3) LENGTH OF CURB EXTENSIONS MUST RECOGNIZE SITE CONDITIONS, EX. DRIVEWAY LOCATIONS.



CURB EXTENSION - CHOKERS  
 FIGURE 2.6 (4)



RAISED MEDIAN ISLANDS  
 FIGURE 2.6 (5)



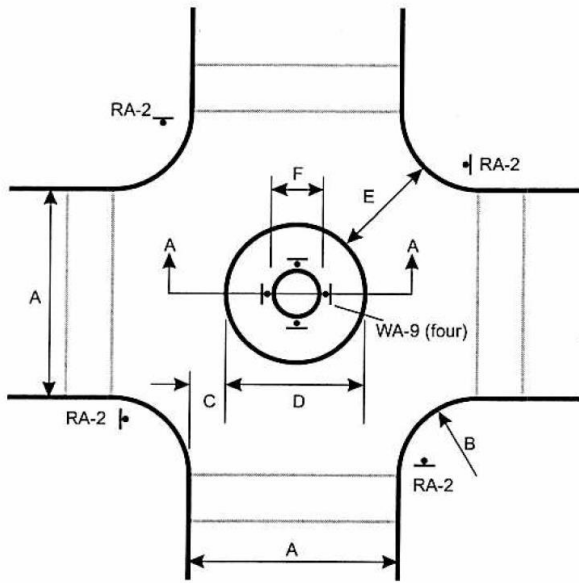
- 1) SIGNS AND MARKINGS SHALL BE IN ACCORDANCE WITH MUTCD & ITE PRACTICES.
- 2) ADVANCE SIGNING AT EACH LOCATION IS OPTIONAL WHEN PART OF AN AREA WIDE SCHEME.
- 3) CROSS-SECTION SHOWS APPROXIMATE ELEVATION FOR 3" (MAX) SPEED HUMP
- 4) SPEED HUMPS SHALL NOT BE PLACED OVER MANHOLES, VALVES, JUNCTION BOXES, ETC.
- 5) SPEED HUMPS MUST BE PLACED AT LOCATIONS APPROVED BY THE CITY ENIGNEER
- 6) DESIGN SHALL BE MODIFIED TO ACCOMMODATE FIELD CONDITIONS (EX. DRAINAGE).



N.T.S  
SPEED BUMP  
FIGURE 2.6 (6)

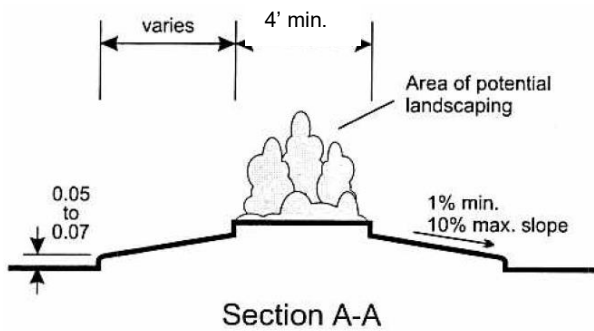


Figure 2.6 (7) Mini Traffic Circle



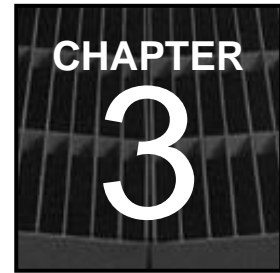
Dimension Chart for Varying Roadway Widths				
A Roadway Widths	B Curb Return Radius	C Off-set Distance	D Circle Diameter	E Min. Opening Width
20	15.5	5.5	8.5	16.0
	17.5	5.0	9.0	16.5
	22.5	4.5	10.5	18.0
	26.5	4.0	11.5	19.0
24	14.0	5.5	12.0	16.0
	16.0	5.0	12.5	16.5
	21.0	4.5	14.0	18.0
	25.5	4.0	15.0	19.0
28	12.0	5.5	15.0	16.0
	14.0	5.0	15.5	16.5
	19.5	4.5	17.0	18.0
	24.0	4.0	18.5	19.5
32	10.5	5.5	15.5	16.0
	12.5	5.0	19.0	16.5
	17.5	4.5	20.5	18.0
	22.0	4.0	22.0	19.0
36	10.0	5.5	22.0	16.5
	11.0	5.0	22.5	16.5
	16.0	4.5	23.5	18.0
	20.0	4.0	25.0	19.0
40	11.0	5.0	26.0	17.0
	12.0	4.5	27.0	17.0
	18.5	4.0	28.0	19.0
	22.0	3.0	29.5	20.0
44	10.0	5.0	29.5	17.0
	13.0	4.5	30.0	18.0
	17.0	4.0	31.5	19.0
	21.0	3.0	33.0	20.0

- Legend:
- A Roadway Width
  - B Curb Return Radius (10' min.)
  - C Off-Set Distance (5' max.)
  - D Circle Diameter
  - E Opening Width (See Table above)
  - F Raised Island Diameter (4' min.)



Minimum Opening width to be provided to all crosswalks  
 A deflection triangle painted on the pavement on each approach to the traffic circle may be appropriate.

**NOT TO SCALE**



---

## DRAINAGE DESIGN

Section	Section Title	Article	Article Title	Pg
3.1	Overview			3-2
3.2	Requirements	3.2.1	Design Criteria	3-2
		3.2.2	Drainage and Hydrology Calculations	3-3
3.3	Ditch Sections			3-4
3.4	Detention / Retention Basins			3-4
3.5	Best Management Practices (BMPs)			3-4
3.6	Inspection and Laboratory Testing			3-4

### 3.1 Overview

As it relates to roadways, the objective of surface drainage is to remove storm water from the traveled roadway as rapidly as possible so that traffic may move safely and efficiently. This is accomplished through careful roadway engineering practices such as using proper cross slopes, longitudinal grades, and cross drainage structures. Streets are not to be designed as conveyance systems for surface water. However, all streets must be so designed as to provide for the discharge of surface water from the right-of-way of the streets by grading and drainage as shall be approved by the Street Department Director and the City Engineer. Hydraulic capacities and locations of drainage structures in the public street right-of-way shall be designed to take into consideration upstream and downstream properties and to secure as low a degree of risk of traffic interruption by flooding as is consistent with the importance of the street being designed.

In the case of private development design, the planning and design of the overall drainage system shall be done simultaneously with the road or street layout and gradient planning and design. Where positive lot drainage is proposed, coordination of the road or street grades and the finished lot elevations must be achieved.

### 3.2 Requirements

#### 3.2.1 Design Criteria

##### (1) Design Frequency

Design frequency for roadway drainage facilities is based on achieving a balance between construction cost, maintenance needs, amount of traffic, potential flood hazard to adjacent property and expected level of service. The design frequencies presented below are the minimum that will achieve this balance for the various road classifications and types of drainage facilities.

Cross structures and drainage structures shall be designed based on the design frequencies in **Table 3.1** such that they:

- i. Shall not significantly increase the flood hazard for adjacent property;
- ii. Shall permit maintenance of traffic on roads and streets under design flood conditions.
- iii. Shall limit the encroachment onto the traveled lanes which could cause a hazard to traffic.

	Interstate and Limited Access Roadways	Arterials	Collectors	Local Road
Inlet Design Frequency	50-yr	10-yr	10-yr	10-yr
Storm Sewer Design Frequency	50-yr	10-yr	10-yr	10-yr
Culvert Design Frequency	50-yr Check for 100-yr	50-yr Check for 100-yr	50-yr Check for 100-yr	50-yr Check for 100-yr
Roadway Freeboard	50-yr	50-yr	50-yr	50-yr
Ditch Design Frequency	50-yr	10-yr	10-yr	10-yr

Table 3.1

## **(2) Drainage Inlets**

Drainage inlets shall be designed and located to limit the spread of water on the traveled way to no more than one half of the travel lane width. Bike lanes and shoulders may be used full width for spread. Because grates may become blocked by trash accumulation, combination inlets with both grate and curb openings shall be used when possible. Inlets and grates shall be located outside the travel lanes to minimize shifting of vehicles attempting to avoid them, and shall be designed to accommodate bicycle and pedestrian traffic where appropriate. Drainage inlets shall be provided at all locations where ponding is possible, including at the downstream end of inset on-street parking bays. Low points in streets and at the end of cul-de-sacs shall have a minimum double inlet. Inlets shall be moved to curb when adding turn lanes.

## **(3) Storm Sewers**

Where water cannot be adequately discharged by surface drainage, storm sewers shall be required. Public streets are not to be used to collect and convey storm water runoff other than that which falls on a lot fronting that street. Significant runoff from adjacent hillsides shall be intercepted prior to surface flowing into streets or alleys. In addition, the street and drainage design shall be such that storm water runoff shall not be allowed to flow across street intersections. The minimum slope of storm sewer pipes shall not be less than 0.50%. Flow shall not be directed into a junction at an angle less than 90 degrees from that leaving the junction. Headwalls shall be oriented to be in line with the flow. Flow from the 10-year design storm event shall not surcharge above storm sewer interior crown elevations or create hydraulic jump conditions. The inside area of downstream pipes shall not be less than the inside area of upstream pipes. All storm pipes shall terminate into a storm structure or headwall. Exposed plain pipe ends are not permitted.

### **3.2.2 Drainage and Hydrology Calculations**

The Engineer of Record shall determine the appropriate analysis method for determining flows and design of the drainage system for both volume and water quality requirements. The rational method shall be an acceptable method for peak flow estimating for drainage basins of less than one hundred (100) acres. The Engineer of Record should be familiar with the limitations of each of the methods so that appropriate methods are applied. The City Engineer may require a particular method on critical portions of the drainage system. The methods shall be limited to and comply with the methods as outlined in the "TDOT Standard Specifications".

Drainage and hydrology calculations shall be submitted with the construction plans. The calculations shall include:

- Drainage area calculations include area in acres, runoff coefficients, a description of runoff calculation methods used, including rainfall intensity, and runoff (Q) used in calculations.
- Culvert cross sections clearly showing invert and outlet elevations, culvert lengths, roadway elevation and lengths.
- Energy Dissipation Design calculations.
- Computer analysis report output. Method shall be acceptable to the City Engineer.
- Force effects (including earth pressure, dead load, and vehicular dynamic loading) on buried drainage structures if requested by the City Engineer.
- Summary of high water elevations if open channel flow is present.

All necessary support data shall be submitted, including a map detailing the drainage basin and sub-basins, storm event, methods for calculating peak runoff, headwater and tail water conditions (assumed and calculated), methods for sizing channels and culverts, flow depths on channel and channel lining calculations. All design drawings, calculations and support data shall be submitted to

the City Engineer for approval and must be sealed by a registered Professional Engineer licensed to practice in the State of Tennessee.

---

### **3.3 Ditch Sections**

Erosion Prevention and Sediment Control is a significant issue during and after construction. The City has a Stormwater Management Ordinance that serves as the City's primary Stormwater guideline. Adherence to these ordinances is required at all times during the construction of ditch sections to ensure that slopes and channels will continue to function adequately.

---

### **3.4 Detention / Retention Basins**

Detention basins are used to collect and hold stormwater runoff for a period of time to compensate for increases in stormwater runoff caused by reduced ground surface perviousness due to activities such as paving or building construction. Retention basins are similar to detention, but they retain a certain portion of the runoff in the basin. Both types of basins must adhere to the current edition of the City's Stormwater Ordinance.

---

### **3.5 Best Management Practices (BMPs)**

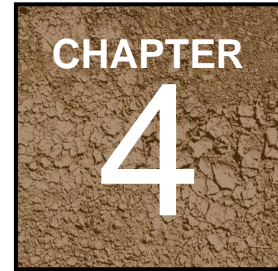
The City has compiled a Best Management Practices Stormwater Management Manual that is designed to assist contractors, developers, and various businesses and industries to comply with the guidelines set forth by the National Pollution Discharge Elimination System (NPDES) Phase II Rule. The BMP Stormwater Management Manual should serve as the major tool to insure that the guidelines set forth in the City's Stormwater Management Ordinance are followed during the design and construction of transportation projects.

---

### **3.6 Inspection and Laboratory Testing**

The owner's engineer or his representative, familiar with assumptions inherent in the structure design, shall review the construction in sufficient detail to confirm that the construction is as specified. Inspection shall occur as frequently as necessary to assure that the construction conforms to the plans and specifications. Inspection shall be by qualified technical personnel experienced in the inspection of similar structures. Reference the "*Pipe Inspection & Evaluation Guidance Document for City of Franklin Stormwater Infrastructure*" on the City of Franklin Engineering webpage for other pipe inspection requirements.

It is the developer's responsibility to perform all materials testing. Testing of materials shall conform to the requirements of "*TDOT Standard Specifications*" and applicable interims.



# EARTHWORK AND DEMOLITION

Section	Section Title	Article	Article Title	Pg
4.1	Overview			4-2
4.2	Reference Specifications			4-2
4.3	Clearing and Grubbing	4.3.1	Tree Protection	4-2
		4.3.2	Burning Permit	4-2
		4.3.3	Debris Removal	4-2
4.4	Excavation	4.4.1	Property Protection	4-2
		4.4.2	Structure Excavation	4-3
		4.4.3	Channel Excavation	4-3
		4.4.4	Blasting	4-3
4.5	Undercutting	4.5.1	Limits of Undercutting	4-3
		4.5.2	Proof-Rolling	4-3
		4.5.3	Backfill	4-3
		4.5.4	Stabilization	4-3
4.6	Embankment			4-3
4.7	Trench Excavation	4.7.1	Existing Street Cuts	4-4
		4.7.2	Backfill	4-4
		4.7.3	Flowable Fill Backfill	4-4
		4.7.4	Pavement Replacement	4-4
4.8	Underdrains			4-4
4.9	Street Damages			4-4
4.10	Demolition	4.10.1	Removal of Drainage Structures	4-5
		4.10.2	Removal of Pavement, Sidewalk, Curbs, Etc.	4-5

#### 4.1 Overview

This Section includes all clearing and grubbing, stripping topsoil, excavation, embankment, trench excavation, backfilling, demolition of transportation features/structures and testing required for construction of city streets within the City. Earthwork embankments and excavations shall be constructed in close conformance with the lines, grades and typical cross sections shown on the approved plans. Work associated with demolition and abandonment will consist of the demolition, removal and satisfactory disposal of items that have been selected for demolition on approved construction plans. Demolition will not be approved until satisfactory arrangements have been made to maintain traffic. Demolition of all items, including those not detailed below, shall be coordinated with the City and/or the Director of Building and Neighborhood Services Department. For all earthwork operations, the developer/contractor will be required to provide testing from an independent geotechnical firm pre-approved by the City.

---

#### 4.2 Reference Specifications

Unless modified by these Standards, all earthwork materials and construction requirements shall conform to "TDOT Standard Specifications".

---

#### 4.3 Clearing and Grubbing

Clearing the right-of-way of all vegetation and debris shall be limited to an area bounded by a line established within the project limits unless otherwise directed by the engineer. Complete removal of shrub and tree roots is required except for sound undisturbed stumps and roots that will be a minimum of 5 feet below proposed subgrade or slopes which may be allowed to remain.

**4.3.1 Tree Protection:** Living trees with drip lines located beyond the construction lines are to remain undisturbed and protected by the contractor. The Developer will be responsible for establishing the lines of construction clearing in accordance with the above requirements.

**4.3.2 Burning Permit:** Burning of cleared vegetation and perishable debris is not allowed unless approved by the City Fire Department by issuance from the Fire Marshall of the required burn permit.

**4.3.3 Debris Removal:** Unless otherwise approved, all debris (i.e. cleared trees, brush, fences, building materials, etc.) shall be removed from the right-of-way, out of view from the street, and shall not be buried or otherwise become part of the street subsurface. Removal of cleared materials from the developer's property shall be legally disposed of.

---

#### 4.4 Excavation

Excavation within the right-of-way includes stripping topsoil, grading of the street and required ditches, borrow material, channel excavation, rock excavation and undercutting. Excavation shall be performed in close conformance to the lines, grades, side slopes and typical cross sections of the approved construction plans.

**4.4.1 Property Protection:** Excavation shall be performed in a safe and orderly manner with due consideration given to protection of adjoining property and trees outside the clear lines. Approved erosion control measures shall be installed and regularly maintained to insure protection of adjacent properties. Excavated material when required shall be stockpiled in such a manner as to not obstruct streets, driveways or sidewalks.



**4.4.2 Structure Excavation:** Excavation for bridges and pipes shall be in accordance with "TDOT Standard Specifications". Excess rock excavation below foundation elevations shall be filled with leveling concrete. Excess rock excavation below the elevation of the bottom of the pipe bedding, cradle or encasement shall be filled with material of the same type and placed and compacted in the same manner as the bedding material.

**4.4.3 Channel Excavation:** Excavation within waterways will require approved permits prior to commencing operations, and the equipment shall be kept out of the waterway to the greatest extent possible.

**4.4.4 Blasting:** Rock excavation requiring blasting shall be performed only after obtaining blasting permits from the City of Franklin Fire Marshall. Blasting operations shall be performed only by experienced, licensed blasting contractors. Blast areas shall be protected with mats or earth overburden to prevent flying debris. When blasting near public areas or motorists, blast zones are to be set up with proper signing and flagmen to secure the blast area prior to detonating explosives. The contractor shall be responsible for all damages and shall repair or replace any and all damages at no expense to the City. A pre-blast survey will be required by the Engineering Department.

---

## 4.5 Undercutting

When unsuitable material such as tree roots, trash, concrete and asphalt fragments or soft organic or plastic clays are encountered in the subgrade, the area shall be undercut and backfilled with select material.

**4.5.1 Limits of Undercutting:** Areas and depths of undercutting required for existing streets will be determined by City officials during inspections of subgrade construction and for final acceptance of city streets. The extent of undercut areas shall be determined by proof-rolling the subgrade. Undercutting required after curbs are installed shall be located no closer than 12 inches from the nearest concrete face.

**4.5.2 Proof-Rolling:** Vehicles for proof-rolling shall be tandem axle dump trucks fully loaded with a minimum material payload of 23 tons.

**4.5.3 Backfill:** Suitable material shall consist of approved, competent soil from the site that matches the soil classification of the subgrade, or approved classified rock (surge rock). Backfill material shall be placed in lifts not to exceed 12 inches, and each lift shall be compacted with a dozer or other approved heavy equipment.

**4.5.4 Stabilization:** Geotextile fabrics may be used to strengthen backfill material in undercut areas provided the contractor can demonstrate their effectiveness on test repair areas at the same site or based on the recommendations of a pre-approved geotechnical engineer.

---

## 4.6 Embankment

Embankment material shall consist of approved soil or rock obtained from on-site excavations or hauled from a borrow pit area, and shall be placed in fill embankments in reasonably close conformance with the

lines, grades, side slopes and typical cross sections shown on the approved plans. All embankments shall be placed in accordance with "*TDOT Standard Specifications*".

---

#### **4.7 Trench Excavation**

Trenches cut within the limits of the subgrade shall be excavated to neat lines to minimize disturbance of the surrounding material. The contractor/ developer is solely responsible for the stability of trench excavations and conformance with OSHA regulations.

All excavation for pipe and utility installation shall be performed in accordance with the "*TDOT Standard Specifications*".

**4.7.1 Existing Street Cuts:** Utility trenches cut into existing streets shall be performed in such a manner as to maintain the existing integrity and rideability of the street. Trench limits shall be saw-cut a minimum of 2-inch deep into the existing pavement. Excavation width shall be limited to the minimum width required to permit satisfactory jointing of the pipe and thorough backfilling.

**4.7.2 Backfill:** Utility trenches excavated into existing streets shall be backfilled as indicated on the Standard Drawings. Each layer of backfill material shall be placed with optimum moisture content and thoroughly compacted with mechanical tampers.

**4.7.3 Flowable Fill Backfill:** For trench excavations subject to moderate and heavy truck traffic, the excavation shall be backfilled with flowable concrete fill. Pipe bedding shall be installed and thoroughly compacted prior to placement of flowable fill material.

**4.7.4 Pavement Replacement:** Base stone and asphalt paving shall be placed over trench backfill with thicknesses and gradations equal to the existing street pavement section, see Standard Drawings. Each course of base stone and asphalt shall be thoroughly compacted with mechanical tampers. Trench excavations within public streets shall be milled and overlay a minimum of fifty (50) feet on either side of the trench unless otherwise approved by the City Engineer.

---

#### **4.8 Underdrains**

In addition to stormwater drainage structures and appurtenances, subgrade underdrains are required under city streets adjacent to medians with irrigation systems. Underdrains shall consist of free draining crushed stone, 4-inch diameter perforated pipe and filter cloth. All underdrains shall be constructed in accordance with "*TDOT Standard Specifications*".

---

#### **4.9 Street Damages**

Damage to existing streets and structures, utilities, trees, or private property shall be repaired and restored to its original condition by the Contractor.

---

## **4.10 Demolition**

### **4.10.1 Removal of Drainage Structures**

Where portions of existing drainage structures lie within the limits for a new structure, they shall be removed as necessary to accommodate the construction of the proposed structure. Pipe designated to become the property of the City of Franklin shall be carefully removed and every precaution taken to avoid breaking or damaging the pipe.

### **4.10.2 Removal of Pavement, Sidewalks, Curbs, Etc.**

All pavement, base course, sidewalks, curbs, gutters, driveways, etc. shall be removed and disposed of as follows: If the items are more than two feet below sub-grade elevation, they shall be broken into sizes not to exceed two feet in maximum dimension and remain in place, unless it interferes with succeeding items of construction. If the items are less than two feet below the sub-grade elevation, they shall be removed and disposed of.

Failure of the plans to identify the existing of concrete pavement under asphaltic pavement shall not be construed to imply that concrete is not present. It is the contractor's responsibility to determine the presence of concrete pavement when it is not identified by the plans.

**CHAPTER**  
**5**

**PAVEMENT DESIGN**

Section	Section Title	Article	Article Title	Pg
5.1	Overview			5-2
5.2	Requirements	5.2.1	General Criteria	5-2
5.3	Design Criteria	5.3.1	Design Factors	5-3
		5.3.2	Special Considerations	5-3
		5.3.3	Special Requirements	5-5
5.4	Asphaltic Concrete Pavement Design			5-5
5.5	Rigid Pavement Design			5-5
5.6	Design Report			5-5
5.7	Installation			5-6
5.8	Testing, Inspection and Acceptance			5-6

## 5.1 Overview

The Contractor (Developer) shall provide all plant, labor, material and equipment to furnish and construct the bituminous concrete pavements in conformity with the lines, grades, thickness and typical cross sections shown on the construction standards and specified herein, or as called for on the approved plans and specifications.

The specifications referenced for each material shall fully apply and no deviations from said specification limits or quality will be permitted unless specifically stated otherwise in this Section. The failure of any component of a product to comply with the referenced specifications shall constitute failure of the whole product.

The Contractor (Developer) shall obtain approval of the subgrade and stone base from the Street Department Director prior to commencing with the paving operations.

For all paving operations, the developer/contractor will be required to provide testing from an independent geotechnical firm pre-approved by the City. See **Chapter 1** for additional testing and inspection requirements

---

## 5.2 Requirements

### 5.2.1 General Criteria

#### (1) Existing Streets

For existing streets, the City Engineer may require testing of the existing pavement and base structure to determine if an overlay is feasible, or if reconstruction is necessary. The City Engineer shall notify the Developer if and when this testing is required prior to the Final Pavement Design Report.

#### (2) TDOT Design Standards

The design criteria and procedures presented follow "*TDOT Standard Specifications*".

#### (3) Pavement Type

Streets are to be constructed of asphaltic concrete pavement, base course material, or subbase material (where required), placed on compacted subgrade.

#### (4) Treated Subgrade

The use of treated subgrade, treated base, and/or full depth asphalt pavement may be acceptable when designed and submitted by the designer, and approved by the City Engineer in accordance with these standards as well as "*TDOT Standard Specifications*".

#### (5) Approval

A preliminary pavement design shall be submitted with final construction plans. The City Engineer shall review and approve the Pavement Design Report prior to construction.

---

## 5.3 Design Criteria

### 5.3.1 Design Factors

#### (1) ADT & Equivalent Daily Load Applications (EDLA)

Loading values can be calculated using TDOT approved ADT numbers or Equivalent Daily Load Applications (EDLA) and Equivalent Single Axle Loads (ESAL) units if available. The City of Franklin Major Thoroughfare Plan traffic data shall be used as a reference.

#### (2) Minimum Pavement Section

The Standard Drawings provide the default acceptable pavement sections for each street classification based on assumed subgrade support and traffic values. These pavement thicknesses may be used for preliminary planning purposes, cost estimates, or final pavement designs when approved by the City Engineer. All pavement thickness designs must be based on actual subgrade support test results and traffic projections for the specific project. In specifying layer thickness, the designer shall consider how the pavement section will be physically constructed (e.g. Specify how to construct 2' of treated subgrade.)

#### (3) Flexible Pavement Strength Coefficients

Nonstandard design coefficients may be used, only if approved in advance by the City Engineer. In addition, design values must be verified by pre-design mix test data and supported by daily construction tests.

### 5.3.2 Special Considerations

On paved surfaces, within public right-of-ways, do not use or operate tractors, bulldozers, off-road trucks or other power-operated equipment, the treads or wheels of which are so shaped as to cut or otherwise damage such surfaces. Damaged roadways shall be repaired to the City's satisfaction by the Contractor (Developer). Placing of mats or using other methods of protection may be allowed subject to the approval of the Street Department Director.

Any roadway surface damaged shall be promptly restored to a condition at least equal to that in which they were found immediately prior to the beginning of operations. Suitable materials and methods shall be used for such restoration. All dirt and mud tracked on existing roadways shall be removed promptly.

Prior to overlaying existing asphalt, the City Engineer may require nondestructive testing to determine the amount of overlay necessary to bring the street to current standards. The method of nondestructive testing and the data obtained must be in a form compatible with the pavement management system for the City Engineer. All "pot-holes," utility trench settlement, cracking, and any similar imperfections shall be repaired to the City Engineer's satisfaction prior to overlaying. The following shall serve as a guideline for the rehabilitation and repairing of existing asphalt streets in the City:

(1) **General** - The contractor is to provide the necessary labor, materials and equipment to restore and maintain the various street and driveway surfaces of all types, pavement and driveway bases, curbs, curbs and gutters, and sidewalks disturbed, damaged, or demolished during the performance of the work.

**(2) Permits** - Before starting any work, secure the necessary permits to work within the City or State ROW and easements when surface materials will be disturbed or demolished. Separate street excavation permits are required for street cutting and road subsurface boring/jacking operations. See City of Franklin Municipal Code for permit requirements and fees.

**(3) Materials**

The quality of materials used in the restoration of existing streets, parking areas and driveways shall produce a finish surface equal to or better than the condition before work began. Compacted crushed stone backfill shall be in conformance with "*TDOT Standard Specifications*".

Asphalt for a temporary patch shall be Bituminous Plant Mix Surface Course (Cold Mix) as specified in "*TDOT Standard Specifications*".

**(4) Execution**

Where trenches have been opened in any roadway or street that is a part of the State of Tennessee highway system, restore surfaces in accordance with the requirements of "*TDOT Standard Specifications*". All other restorations shall be done in accordance with the City Standards;

Before trenching in paved areas the Contractor shall saw-cut the pavement in a straight line along the sides of the proposed trench to allow for pavement removal and trench excavation without damage to adjacent pavement. During construction, suitable precautions shall be taken to protect the pavement edges and surfaces and to minimize damage.

Upon completion of the utility installation, including backfill, fill the trench with crusher run and temporary pavement patch until such time that the permanent pavement patch will be constructed. The temporary patch shall be placed the same day or within 24 hours. The temporary pavement patch shall consist of at least twelve (12) inches of compacted stone base brought to within two (2) inches of the surface of the existing permanent pavement. A two (2) inch layer of cold mix asphaltic concrete shall then be applied to protect the base, prevent "pot holes" or "chuck holes", and provide a reasonably smooth pavement surface until the permanent patch is made. The temporary pavement patch shall be placed within twenty-four (24) hours of the completion of the utility installation. Permanent Hot Mix patching shall only be applied after the Cold Mix patch has been completely removed.

Concrete curbs, gutters and sidewalks shall be restored as required to match existing construction. Replace damaged sections with complete new sections or squares; patching of damaged sections will not be permitted.

When a manhole or valve box frame and cover, or other utility casting, requires adjustment to an elevation one inch or more above the existing pavement grade and is exposed to traffic before final paving is completed, a temporary ramp shall be constructed by feathering a cold mix for 360 degrees around the casting. A taper slope of not less than two feet per one inch shall be used. During the final paving operation, the temporary ramp shall be removed from around the casting to allow for the permanent paving installation.



### 5.3.3 Special Requirements

Unless otherwise determined by the City Engineer, full-depth milling and resurfacing of the roadway shall be required for all cuts within the roadway limits. The limits of milling and resurfacing shall extend 50' past the trench edge in each direction. The final limits of associated with milling and resurfacing shall be determined by the City Engineer.

---

## 5.4 Asphaltic Concrete Pavement Design

Pavement is required to be a 20-year design. All pavement design shall comply with "TDOT Standard Specifications" and meet or exceed the minimum requirements as shown in the Standard Drawings.

---

## 5.5 Rigid Pavement Design

For concrete rigid pavement, see **Chapter 6, Concrete**, for concrete riding surfaces.

---

## 5.6 Design Report

The pavement design report shall be prepared by an independent geotechnical laboratory under the supervision of and signed and stamped by a Professional Engineer registered in the State of Tennessee. The report shall make a recommendation for a typical pavement structural section based on known site soil conditions and the valid traffic impact study. The following list of items shall be included in the report:

- (1) Vicinity map to locate the investigated area.
- (2) Scaled drawings showing the location of final borings.
- (3) Final Plat with street names.
- (4) Scaled drawings showing the estimated extent of subgrade soil types and EDLA for each street classification.
- (5) Pavement design alternatives for each street classification.
- (6) Tabular listing of sample designation, sample depth, Group Number, liquid limit, plasticity index, percent passing the No. 200 sieve, AASHTO Classification, Group Index and soil description.
- (7) R-value test results of each soil type used in the design.
- (8) Borrow source identification.
- (9) Pavement design computer printouts or nomographs properly drawn to show Soil Support - EDLA - SN
- (10) Design calculations for all phases of soil report.
- (11) Design coefficient used for asphalt, base course, etc.
- (12) A discussion of potential subgrade soil problems including, but not limited to:
  - (a) Heave or settlement prone soils.
  - (b) Frost susceptible soils.
  - (c) Ground water.
  - (d) Drainage considerations (surface and subsurface).
  - (e) Soluble sulfates in subgrade.

(f) Other factors or properties that could affect the design or performance of the pavement system.

(13) Recommendations to alleviate or mitigate the impact of problems discussed in the previous paragraph.

---

### **5.7 Installation**

Installation shall be in accordance with "*TDOT Standard Specifications*".

---

### **5.8 Testing, Inspection and Acceptance**

All pavement installations and repairs will require the contractor to submit material testing certifications to the City Engineer. Materials shall meet the requirements found "*TDOT Standard Specifications*".

The City Engineer reserves the right to request any additional tests deemed necessary for acceptance.

**CHAPTER**  
**6**

**CONCRETE**

Section	Section Title	Article	Article Title	Pg
6.1	Overview			6-2
6.2	Reference Specifications			6-2
6.3	Submittals	6.3.1	Concrete Mix Designs	6-3
		6.3.2	Reinforcing Steel	6-3
		6.3.3	Miscellaneous Items	6-3
6.4	Curbing and Sidewalks	6.4.1	Residential Sidewalks	6-3
		6.4.2	Commercial Sidewalks	6-5
		6.4.3	Bikeways	6-5
		6.4.4	Accessible Ramps	6-5
		6.4.5	Curb and Gutter Sections	6-5
6.5	Stamped Concrete and Brick Pavers	6.5.1	Stamped Concrete	6-6
		6.5.2	Concrete Unit Pavers	6-7
6.6	Rigid Concrete Pavement			6-7
6.7	Concrete Reinforcement	6.7.1	Reinforcing Materials	6-7
6.8	Concrete Placement			6-8
6.9	Inspection and Laboratory Testing	6.9.1	Testing Frequency	6-9

## 6.1 Overview

This Section includes cast-in-place and pre-cast concrete, including reinforcement where required, concrete materials, mix design, placement procedures, and finishes. All concrete pavements, sidewalks, ramps, driveway aprons, curb and gutter sections, paved ditches, pipe and pipe end treatments, box culverts and bridges, drainage structures, foundations and wall panels and all other miscellaneous concrete elements indicated on the approved drawings shall be constructed in accordance with these Standards unless approved otherwise by the City. All concrete shall be ready mixed concrete and not field mixed unless otherwise approved.

The Contractor (Developer) shall provide all materials, labor, and equipment necessary for the completion of all concrete work in accordance with the lines, grades, thickness and typical cross sections shown on the construction standards specified herein, or as indicated on the approved plans.

---

## 6.2 Reference Specifications

Unless modified by these Standards, all concrete materials and construction requirements shall conform to *"TDOT Standard Specifications"*.

Where project plans and specifications refer to particular items, materials, equipment and construction requirements, the appropriate section of *"TDOT Standard Specifications"* shall apply. *"TDOT Standard Specifications"* sections regarding compensation shall not apply unless directed by the City Engineer. The absence of a description or specification for any item of work shall automatically refer to the appropriate section of *"TDOT Standard Specifications"*.

*"TDOT Standard Specifications"* shall apply for all structural concrete to be used in load carrying structures including box and slab culverts, foundations including drilled caissons, traffic signal and overhead sign foundations, retaining walls and girder bridge members. Section 604 also specifies the requirements of concrete used in structures as well as other miscellaneous or incidental items. Miscellaneous concrete items such as sidewalks, curbing and gutters, rigid street pavement, medians, driveways, paved ditches and roadside sign foundations, shall meet the requirements of *"TDOT Standard Specifications"*.

All precast concrete including precast drainage structures, headwalls, box culverts, pipe, temporary barriers, noise and retaining walls, and bridge members shall meet the requirements of TDOT's Standard Operating Procedure regarding the *"Manufacture and Acceptance of Precast Concrete Drainage Structures, Noise wall panels, and Earth Retaining wall products"*. This document requires that all producers of precast concrete products be certified in accordance with national quality standards developed by the National Precast Concrete Association (NPCA), the American Concrete Pipe Association (ACPA) and/or the Prestressed Concrete Institute (PCI). Certified producers must submit a copy of their certifications and documentation that have successfully completed the annual inspections. The City Engineer may waive the requirements of precast concrete producer certification on a case-by-case basis.

---

## 6.3 Submittals

Where required in the project plans, technical performance and/ or quality certification of concrete materials proposed for the work shall be submitted to the City Engineer for approval. Such submittals may include the following:

### 6.3.1 Concrete Mix Designs

Concrete mix designs are required for load carrying structures such as bridges, box culverts, junction boxes within the roadway and retaining walls. Mix designs shall be prepared and certified by approved materials testing company, or alternately, an existing TDOT approved design may be submitted provided the design is approved within the calendar year. Mix designs shall certify all admixtures and cement replacement such as fly ash proposed for the project concrete.

### 6.3.2 Reinforcing Steel

Certifications for reinforcing steel used in load carrying structures shall be submitted to the City Engineer. Letter of certification shall bear the signature of the supplier's representative and shall certify that the reinforcing meets the requirements of "*TDOT Standard Specifications*".

### 6.3.3 Miscellaneous Items

Items included in the concrete work such as handrails, anchors, joint materials, curing materials and other items may require submittals and or representative samples at the discretion of the City Engineer.

---

## 6.4 Curbing and Sidewalks

### 6.4.1 Residential Sidewalks

All residential street sidewalks within the City shall be constructed within the street right-of-way and shall meet all City requirements and standard drawings. The sidewalk forms and base material shall be inspected prior to concrete construction.

It is the contractor's responsibility to ensure safety and maintain access for pedestrians when sidewalks are under construction and to protect the in place work from damage or vandalism.

Traffic control devices including cones, barrels and signs may be required on high volume streets to warn vehicular traffic in advance and adjacent to the area of construction.

(1) All concrete sidewalks shall be a minimum uniform thickness of 4" using Class A Concrete, minimum 28-day compressive strength of 3,000 psi. Sidewalks shall be constructed on 4 inches (minimum) of compacted, granular aggregate base stone (TDOT Class A, Grade D Base Stone). The base stone shall be mechanically compacted to a firm, even surface in reasonably close conformity with the grade and cross section required.

(2) Subgrade soil which in the opinion of the City Engineer is soft or subject to large volume changes, shall be excavated and replaced with suitable material as approved by the City Engineer.

(3) Where driveway and alley approaches cross the sidewalk, the minimum concrete thickness of the approach slab shall be 6". See Standard Drawings for details. Granular base material for driveways shall be compacted base stone material conforming to Class A, Grading D of "*TDOT Standard Specifications*". A 2" lowered curb height above the gutter line shall also be maintained at the front edge of the driveway approach.

(4) Reinforcement of residential sidewalks is required and shall consist of synthetic fiber reinforcement.

(5) Sidewalk cross slope shall be 1.5% (2.0% Max) sloping toward the curb. Longitudinal sidewalk

grades within a street or highway right-of-way shall not exceed the general grade established for the adjacent street or highway. Pedestrian street crossings shall be 5 percent maximum.

**(6)** For detached sidewalks, the difference in elevation between the top of sidewalk and the top of curb at any adjacent location shall not exceed the grade difference produced by a maximum 4:1 slope.

**(7)** Sidewalk surface is to receive a light broom finish, to achieve a sandy texture with texture lines perpendicular to traffic. Exposed aggregate sidewalk finishes are not acceptable within the street right-of-way.

**(8)** All exposed concrete edges shall be rounded to a 1/2" radius.

**(9)** Final longitudinal surface variations shall not exceed 1/4" under a 12-foot straight edge and transverse variation shall not exceed 1/8" in 5 feet. Low spots which allow water to pond will not be acceptable.

**(10)** Transverse control joints shall be spaced 5 feet maximum and shall be placed at right angles to traffic. Joints shall also be placed to intersect all inside or re-entrant corners. Joints shall be formed with a grooving trowel to a depth of 1 inch. The top edges of the grooves shall be rounded to 1/4" radius.

**(11)** Longitudinal control joints are required for sidewalk widths greater than 6 feet and less than 10 feet. Two longitudinal joints are required for sidewalks greater than 10 feet. Longitudinal joints shall be centered in the width of the sidewalk.

**(12)** Expansion joints shall be constructed with 1/2" thick pre-molded rubberized expansion joint filler (manufactured by J.D. Russell Company, or equal). Bituminous fiberboard shall not be used. Expansion joint material shall extend the full width of the sidewalk and the depth shall extend to within 1 inch of the top surface. Space expansion joints at 30 feet maximum spacing and at each driveway and at any cold joint. Expansion joints are also required at the back edge of driveway approaches between the approach and the private drive and at each side interface with the sidewalk.

**(13)** 1" thick pre-molded expansion joints are required when sidewalks are adjacent to curved sections of the street curb and when curb is placed adjacent to buildings and/ or retaining walls. Use 1/2" isolation joints around other fixed objects like utility poles and hydrants. Use 1/2" expansion joints between the curb and sidewalks where constructed adjacent to each other.

**(14)** Sidewalks and bikeways shall not be opened to pedestrian or bicycle traffic for at least 24 hours after placement. The contractor shall provide and maintain measures to restrict use during the curing period.

**(15)** Concrete driveway aprons shall not be opened to vehicular traffic for at least 7 days after placement or until test cylinder breaks indicate an attained compressive strength of 2500 psi.

**(16)** Backfill sidewalks flush with the surface of the walk and the surrounding ground line with soil. For detached sidewalks, backfill the area between the curb and the sidewalk on a straight line from the top of walk to the top of curb, but not to exceed a 4:1 slope.

#### **6.4.2 Commercial Sidewalks**

In addition to and including the above requirements for residential street sidewalks, commercial sidewalks within the City shall be constructed to the following requirements:

- (1) Driveway and alley approaches crossing the commercial sidewalks shall have a minimum concrete thickness of 8 inches. See Standard Drawings for details. Granular base material for driveways shall be compacted base stone material conforming to Class A, Grading D of "TDOT Standard Specifications". A 2-inch lowered curb height above the gutter line shall also be maintained at the front edge of the driveway approach.
- (2) Isolation joints are required around penetrations in the sidewalk such as fire hydrants, utility poles, manholes, and adjacent to any fixed structure such as a building or retaining wall. Use 1" thick joints against buildings and retaining walls and 1/2" thick pre-molded non-bituminous expansion joint material shall be used in all other locations.
- (3) All valve boxes, manhole covers and other castings in the sidewalk area shall be adjusted to the grade of the sidewalk.
- (4) Commercial sidewalk widths shall be specifically reserved for pedestrian travel. Furniture, planters, newspaper stands and other protruding obstacles shall be kept clear of a minimum required width of 4 feet. Obstacles in the pedestrian path shall be eliminated or a widened pathway around the obstacle will be required.

#### **6.4.3 Bikeways**

Where desired, concrete bike paths within the City shall be constructed using the same requirements of commercial sidewalks except that control joints shall be saw cut 1" deep through the concrete slab in lieu of tooled joints to improve rideability. Expansion joint material shall be recessed 1/2" minimum below the riding surface.

#### **6.4.4 Accessible Ramps**

All sidewalks within the City shall include compliant accessible ramps at all intersections, crosswalks and commercial driveways. Accessible ramps shall be constructed in accordance with the City Standard Drawings.

- (1) Concrete for ramps to be Class A and shall be finished by light broom finish texturing.
- (2) Install a 1/2-inch pre-molded, rubber expansion joint between the ramp section and the sidewalk and between the ramp section and the curb.
- (3) Truncated dome detectable warning areas shall be installed using Armorcast Detectable Warning Panel or approved equivalent.
- (4) Minimum concrete thickness for an accessible ramp shall be 8 inches.

#### **6.4.5 Curb and Gutter Sections**

All concrete curb and gutter sections shall be constructed in accordance with details shown in the Standard Drawings and the project plans. Curb openings will be located as shown on the approved plans and will be evaluated based on acceptable access control requirements by the City.

- (1) Class A Concrete shall be used for all curb and gutter sections and the concrete mix shall be air-entrained.



- (2) Curb and gutter sections shall be constructed on compacted stone aggregate base for residential and commercial streets. Extruded curbs are to be constructed on asphalt binder course surfaces for residential streets.
  - (3) Curb and gutter sections shall be reinforced with synthetic fiber reinforcing.
  - (4) Control joints for curb and gutter sections shall be spaced at a maximum of 10 feet.
  - (5) Expansion joints are required at all tangent points in curved sections, between curbs and sidewalks and between curbs and other rigid objects such as buildings, catch basins and driveway aprons.
  - (6) Where curbs are attached to the sidewalk, expansion joint spacing shall match the spacing of expansion joints in the sidewalk.
  - (7) Maximum expansion joint spacing for detached curbs shall be 100 feet.
  - (8) Curbs and gutters shall be constructed to follow the geometry of the roadway unless noted otherwise on the plans. Curved sections of curb shall conform to the roadway curve geometry with smooth continuous curves with no chorded portions.
  - (9) Flow lines of gutters shall be true to line and grade with no areas of ponding water. Final longitudinal surface variations shall not exceed ¼ inch under a 12-foot straight edge.
  - (10) Concrete finish for curb and gutter sections shall be a light broom finish with finish lines parallel to the flow of water.
  - (11) Curb and gutter sections aprons shall not be opened to vehicular traffic for at least 7 days after placement or until test cylinder breaks indicate an attained compressive strength of 2500 psi.
- 

## 6.5 Stamped Concrete and Brick Pavers

### 6.5.1 Stamped Concrete

For areas designated by the City, concrete finishing may incorporate imprinting or stamping and coloring of the exposed finish for improved aesthetics. Stamped concrete finishes are to be performed only by qualified contractors with a minimum of five-years experience in commercial concrete stamping finishes. For projects with proposed concrete stamping, the proposed pattern, finish and color shall be submitted with related product data to the City Engineer for approval. Prior to construction, a mock-up sample of a minimum 4 square feet size shall be constructed to demonstrate a typical finished product for review and approval by the City.

Concrete stamped areas may include color of the final surface by applying a colored antiquing release agent just after initial set of the concrete. Concrete may also contain a color additive provided the colorant additive is mixed at the batch plant and the color is completely dispersed in the concrete. After concrete curing, the colored concrete surface shall be sealed with a clear sealer containing at least 30% solids in a minimum of two coats. Alternate method of coloring the concrete surface may be submitted to the City Engineer for approval.

### 6.5.2 Concrete Unit Pavers

While stamped concrete is the preferred method for aesthetic enhancement of concrete surfaces, concrete pavers may be used to create borders or bands within sidewalk areas. Pavers will not be allowed in areas subject to vehicular traffic unless otherwise approved by the City Engineer.

All paver units shall be concrete pavers installed over concrete mats with bituminous adhesives. Clay brick paver units shall not be used. Pavers subject to vehicular traffic shall be required to have a minimum of 10" thick poured concrete base with weep holes filled with bedding material and a ¾" thick bituminous setting bed (E-Mix). All other pavers shall have a minimum of 4" thick poured concrete base with a ¾" thick bituminous setting bed (E-Mix). See Standard Drawings for examples of standard drawings.

---

## 6.6 Rigid Concrete Pavement

For specific locations on city streets with large volumes of truck traffic and damage to asphalt pavement due to braking forces, rigid concrete pavement may be utilized. Typical locations for its use include intersection approaches, particularly at the bottom of steep grades. Thin concrete overlay with thickness of 4 inches or less, commonly referred to as "white topping" and are constructed over existing hot mix asphalt shall not be used on City streets.

Minimum design requirements for new concrete pavements include a fiber reinforced, 8-inch concrete pavement thickness on 10 inches of compacted mineral aggregate base stone. Use of Class CP (3000 psi strength) concrete is a minimum requirement with the additional requirement of High Early Strength cement for a reduced construction time. Concrete pavement construction shall be in accordance with "*TDOT Standard Specifications*".

---

## 6.7 Concrete Reinforcement

Where indicated on the approved drawings, concrete for load carrying structures such as box and slab culverts, bridges and retaining walls shall be reinforced with steel bar reinforcement, welded wire fabric and pre-stressing strands. Sidewalks, curbs, combined curb and gutters and concrete pavement areas shall be reinforced with synthetic fiber reinforcement.

All steel reinforcing materials required for load carrying structures shall meet the requirements of "*TDOT Standard Specifications*" unless noted. Sizes, spacing, gauges, locations and arrangements shall be as shown on the approved plans. Where project plans do not depict reinforcing placement plans or schedules, the contractor shall develop and submit reinforcing steel shop drawings to the City Engineer for approval. All hooked bars shall conform to CRSI standard hook details.

In the case of bridge decks, top slabs of box and slab culverts used as riding surfaces, concrete barrier rails and bridge sidewalks, all reinforcing steel shall be epoxy coated per "*TDOT Standard Specifications*". In addition, the dowel bars projecting from the footing into the back face (backfill side) of the wall stem in retaining walls shall also be epoxy coated.

### 6.7.1 Reinforcing Materials

Use the reinforcing materials below where indicated on the approved plans:

- (1) Steel Reinforcing shall be deformed steel bars conforming to ASTM A 615, Grade 60.

(2) Steel reinforcement for bridge decks and top slab of box bridges and slab culverts when used as the riding surface shall be epoxy coated. All concrete bridge railing shall also require epoxy coated reinforcement.

(3) Smooth steel dowel bars shall conform to ASTM A 615

(4) Plain-Steel Welded Wire Fabric: ASTM A 185, fabricated from as-drawn steel wire into flat sheets.

(5) Prestressing steel shall be in accordance with ASTM A416

(6) Synthetic Fibers (fiber reinforced concrete): Fibrillated or monofilament polypropylene fibers engineered and designed for use in concrete, complying with ASTM C 1116, Type III, 1/2 to 1-1/2 inches long.

---

## 6.8 Concrete Placement

All formwork shall be constructed in accordance with "*TDOT Standard Specifications*" using pre-manufactured metal forms or dressed form lumber and plywood. Formwork shall be adequately braced, mortar tight and true to line and grade. Provisions shall be made during placement of concrete to minimize aggregate separation and ensure proper consolidation throughout the pour. To highlight a few key requirements of "*TDOT Standard Specifications*" in particular, the contractor shall ensure the following placement operations are observed:

(1) Elapsed time from truck loading to delivery and placement shall be limited to 90 minutes when the air temperature is 90 degrees or less. When the air temperature exceeds 90 degrees, this time is reduced to 60 minutes.

(2) Concrete that does not meet the specified limits regarding slump, air content, temperature and delivery time shall not be used unless approved by the City Engineer.

(3) Concrete shall be mechanically vibrated with suitable vibrators operating within the concrete unless otherwise directed by the City Engineer.

(4) Concrete may not be placed from a chute discharge height greater than five (5) feet.

(5) No concrete other than foundation seals shall be placed underwater.

(6) Do not add water to concrete during delivery, at project site, or during placement unless the concrete delivery ticket indicates that mix water was withheld at the plant. In such cases only the amount withheld per cubic yard may be added at the jobsite.

(7) Concrete shall be placed in cold weather only when the air temperature is 40 degrees and rising.

(8) Protect newly placed concrete from air temperatures below 40 degrees with insulation blankets to maintain the concrete temperature at not less than 45 degrees for a period of 120 hours after placement.

---

## 6.9 Inspection and Laboratory Testing

It is the contractor's responsibility to ensure quality concrete meeting "*TDOT Standard Specifications*" is delivered and placed on the project. All quality testing of the concrete shall be performed by an independent testing company pre-approved by the City in accordance with Section 1 of these Standards. All quality testing performed by the testing agency is subject to monitoring and review by the City Engineer to ensure established procedures are followed. Reports of testing shall be certified and submitted to the City within ten days of actual testing to document the quality control before final acceptance of the project. The contractor will be responsible for the costs associated with all testing and also re-testing due to failed acceptance tests.

Required tests for concrete construction to be performed by the testing agency include:

- (1) Slump
- (2) Yield
- (3) Entrained air content
- (4) Mix temperature
- (5) Representative test cylinders

### 6.9.1 Testing Frequency

One composite sample (4 test cylinders) for each day's pour of each concrete mix exceeding 5 cu. yd. but less than 25 cu. yd. plus one set for each additional 50 cu. yd. or fraction thereof.

Concrete placement operations shall be inspected by an on-site superintendent to ensure placement of the concrete meets requirements of "*TDOT Standard Specifications*". On-site inspection is required to be documented by the contractor and recorded in a field book subject to review by the City Engineer.

**CHAPTER**  
**7**

## STRUCTURES

Section	Section Title	Article	Article Title	Pg
7.1	Overview			7-2
7.2	Reference Specifications			7-2
7.3	Pipe Culverts and Storm Sewers	7.3.1	Concrete Pipe	7-2
		7.3.2	Corrugated Metal Pipe	7-2
		7.3.3	High-Density Polyethylene (HDPE) Pipe	7-2
		7.3.4	Poly Vinyl Chloride (PVC) Pipe	7-2
		7.3.5	Pipe Bedding	7-2
		7.3.6	Pipe Sizes	7-2
		7.3.7	Pipe Backfill	7-2
		7.3.8	Pipe Cover	7-2
7.4	Pipe Culvert Endwalls and Inlets			7-3
7.5	Storm Drainage Structures	7.5.1	Catch Basin Castings	7-3
		7.5.2	Concrete Catch Basins and Junction Boxes	7-4
		7.5.3	Additional Pipe Openings	7-4
		7.5.4	Trench Drains	7-4
7.6	Box Culverts and Bridges			7-4
7.7	Pedestrian Bridges			7-4
7.8	Retaining Walls			7-4
7.9	Overhead Sign and Ground Mounted Sign Supports			7-5

## 7.1 Overview

This Section includes all fabricated, installed and erected structures and appurtenances related to street construction including pipes, culverts, headwalls, box culverts and bridges, retaining walls and sign supports.

---

## 7.2 Reference Specifications

Unless modified by these Standards, all structure materials and construction requirements shall conform to "TDOT Standard Specifications".

---

## 7.3 Pipe Culverts and Storm Sewers

Pipe used for storm infrastructure within street right-of-way or public easements shall be rigid concrete pipe, unless otherwise approved by the City Engineer. All pipe culverts, side drains and storm sewers shall be furnished and installed in accordance with "TDOT Standard Specifications".



Reinforced concrete pipe is standard for city streets

### 7.3.1 Concrete Pipe

Concrete Pipe shall be reinforced Class III rigid pipe and shall be round, oval or flat based as shown on the approved plans. All precast concrete pipe shall be manufactured in accordance with the "TDOT Procedures for Manufacture and Acceptance of Precast Concrete Drainage Structures, Noise Wall Panels and Earth Retaining Wall Products".

### 7.3.2 Corrugated Metal Pipe

Corrugated metal pipe shall not be allowed anywhere within the City of Franklin. Extensions of existing Corrugated Metal Pipe shall not be allowed. Existing Corrugated Metal Pipe shall be removed in its entirety and replaced with Rigid Concrete Pipe unless otherwise approved by the City Engineer.

### 7.3.3 High-Density Polyethylene (HDPE) Pipe

This pipe may be used for site drainage, but shall not be used within street right-of-way. Max pipe diameter shall be 36 inches.

### 7.3.4 Poly Vinyl Chloride (PVC) Pipe

PVC pipe shall not be allowed within the City of Franklin.

### 7.3.5 Pipe Bedding

Pipe bedding for pipe shall comply with "TDOT Standard Specifications".

### 7.3.6 Pipe Sizes

Normal pipe sizes readily available from suppliers may be used to satisfy drainage requirements. Minimum pipe size for side drains and storm sewers shall be 15-inch diameter.

### 7.3.7 Pipe Backfill

Pipe backfill shall comply with "TDOT Standard Specifications".

### 7.3.8 Pipe Cover

The minimum depth of cover for storm sewer pipes is twenty-four (24) inches to the top of pavement.



---

## 7.4 Pipe Culvert Endwalls and Inlets

Pipe culvert endwall treatments may be precast or cast-in-place concrete and are required for all pipe locations within the street right-of-way.

(1) End treatments for a culvert shall consist of either an endwall or safety end section conformed to the slope of the roadway embankment. The choice of end treatment for a culvert shall be determined by the type of facility being served, the culvert size and whether the ends of the culvert are within the clear zone as defined by AASHTO Standards. "TDOT Standard Specifications" shall be followed when selecting the appropriate endwall. The City Engineer shall have final determination on the type and final placement of all endwalls.

(2) To improve the aesthetics of pipe headwalls, textured concrete finishes simulating stacked stone may be used. Additionally, veneers of stone or brick may be applied to exposed surfaces to enhance the appearance from the street.



Protected Endwall with Stone Veneer



TDOT Safety Endwall

---

## 7.5 Storm Drainage Structures

Storm drainage structures consist of junction boxes, drop inlets, catch basins and manholes which may be constructed as precast concrete sections or cast-in-place concrete. Inlet and outlet pipes shall extend through the walls of structures a sufficient distance to make connections, but shall be cut flush with the inside surfaces of the box structure.

### 7.5.1 Castings

Castings that are damaged during construction will be rejected. Castings shall be set true to line and grade. Standard catch basin grates shall be per "TDOT Standard Specifications" or as specified in the Standard Drawings, or as approved by the City Engineer. Grade adjustment rings shall be precast concrete in conformance with ASTM C 478.



Vane grate for curb and gutter section



### **7.5.2 Storm Drainage Structures**

Storm Drainage Structures shall be precast concrete or cast-in-place where directed by the Engineer. Drainage structures shall be designed and detailed on the plans or shall be "*TDOT Standard Specifications*". Knockout structures shall not be used.

### **7.5.3 Additional Pipe Openings**

All boxes, existing or new installation, requiring additional pipe openings shall be neatly cored by means of mechanically sawing through wall of structure. Any damages caused to the structure or use of other means to create openings may require replacement, as determined by an authorized representative of the City of Franklin.

### **7.5.4 Trench Drains**

Trench drains shall not be used within public right-of-way unless otherwise allowed by the City Engineer.

---

## **7.6 Box Culverts and Bridges**

Box culverts and bridges shall be designed in accordance with AASHTO's "*LRFD Bridge Design Specifications*" and "*TDOT Standard Specifications*". Design drawings shall be sealed by a Professional Engineer licensed to practice in the State of Tennessee.

Bridges spanning the floodway shall provide a minimum clearance of 1-foot between the 100-year base flood elevation (BFE) and the lowest point of the bridge superstructure. Bridges shall also be able to pass the 500-year flood without structural failure.

---

## **7.7 Pedestrian Bridges**

Pedestrian bridges shall be designed in accordance with the AASHTO "*LRFD Guide Specification for Design of Pedestrian Bridges*" (latest edition). Design drawings shall be sealed by a professional engineer licensed to practice in the State of Tennessee. Where pedestrian bridges allow passage of maintenance vehicles and small trucks, the vehicular loading shall be accounted for in the design of the bridge. For bridges prohibiting maintenance vehicular traffic, provisions shall be made to restrict access by means of suitable barriers, bollards or other permanent barricades.

---

## **7.8 Retaining Walls**

Retaining walls shall be designed in accordance with the AASHTO "*LRFD Bridge Design Specifications*" (latest edition). Design drawings for retaining walls be sealed by a professional engineer licensed to practice in the State of Tennessee.

Retaining walls shall meet the following requirements:

1. Retaining walls shall be designed for a live load surcharge corresponding to the maximum design loading, but in no case less than 250 psf applied over the full extents of right-of-way.
2. Retaining walls shall provide a minimum sliding and overturning factor of safety of 1.50 and a minimum global stability factor of safety of 1.30.
3. Unless otherwise permitted by the City Engineer, retaining walls and associated components shall be wholly located outside of right-of-way and public easements.

4. Retaining walls outside of, but supporting, right-of-way or public easements shall not be constructed of timber or grouted or ungrouted stacked stone.
  5. Retaining walls within right-of-way or public easements shall consist of cast-in-place reinforced concrete walls meeting TDOT standards and incorporate aesthetic features such as form liners or stone veneers with a non-sacrificial (i.e. permanent) anti-graffiti coating, as approved by the City Engineer.
  6. Pedestrian and/or vehicular guards shall be provided when a pedestrian and/or vehicular path, respectively, extends to within five (5) feet of the top of a retaining wall or where otherwise deemed necessary by the City Engineer.
- 

### **7.9 Overhead Sign and Ground Mounted Sign Supports**

Sign support structures and foundations shall be designed, fabricated and erected in accordance with "*TDOT Standard Specifications*". Design drawings for overhead sign supports shall be sealed by a professional engineer licensed to practice in the State of Tennessee.



## SIGNAL DESIGN

Section	Section Title	Article	Article Title	Pg
8.1	Introduction			8-2
8.2	Administration	8.2.1	Signal Warrants	8-2
		8.2.2	Engineering Study	8-2
		8.2.3	Signal Spacing	8-2
		8.2.4	Private Benefit Signals	8-3
		8.2.5	Designer Prequalification's	8-3
		8.2.6	Intersection Design Study (IDS)	8-3
8.3	Design Standards	8.3.1	Referenced Standards	8-3
		8.3.2	Design Requirements	8-3
		8.3.3	Traffic Signal System Requirements	8-6
		8.3.4	Electrical Requirements	8-6
		8.3.5	Construction	8-6
		8.3.6	Materials and Construction Notes	8-6
		8.3.7	Pedestrian Signals and Timings	8-6
8.4	Signal Phasing and Timing	8.4.1	Purpose	8-7
		8.4.2	Vehicle Clearance Intervals	8-7
		8.4.3	Pedestrian Control Features	8-8
		8.4.4	Pedestrian Push Button Usage	8-8
		8.4.5	Walk Rest Modifier Option	8-8
		8.4.6	Minimum Vehicle Green Times	8-8
		8.4.7	Main Street and Side Street Definitions	8-9
		8.4.8	Left-Turn Signal Phasing Guidelines	8-9
		8.4.9	Protected/Permissive Left-Turn Phase Operation	8-9
		8.4.10	Split-Phase Timing Operation Guidelines	8-10
		8.4.11	Leading/Lagging Left Turn Operation	8-12

## 8.1 Introduction

The purpose of this chapter is to outline the City's review process for traffic signal plans and highlight basic design requirements for traffic signal installations and/or modernizations. This chapter outlines plan and design requirements for the various stages of review and also discusses some basic design elements the City requires on traffic signal projects.

Traffic signal technology changes at a rapid pace; the City reserves the right to change its traffic signal standards and specifications at any time without advance notice.

---

## 8.2 Administration

### 8.2.1 Signal Warrants

For the installation of traffic signals to be considered, the location must satisfy the warrants outlined in the most recent edition of the "MUTCD". In high growth areas where significant changes in traffic conditions are expected due to the development of the area, hourly volumes for 5 years after full build-out shall be estimated and compared with the "MUTCD" signal warrants. The growth rate utilized to estimate the future traffic volumes is subject to the review and approval of the City Engineer prior to its use. The satisfaction of a traffic signal warrant or warrants shall not in itself require the installation of a traffic signal. The City Engineer shall make the final recommendation regarding the location of any new traffic signal. For state routes within the city, TDOT and City will review to make final decisions regarding signal warrants.

### 8.2.2. Engineering Study

An engineering study will be required for all proposed traffic signal installations. The engineering study shall evaluate the effects of the proposed traffic signal on progression. The engineering study shall include the estimation of future volumes and an analysis of the progression of traffic through the signal system, as defined by the City Engineer. The evaluation shall include any planned future traffic signal installations. The analysis shall be submitted to the City Engineer for review and shall include capacity analysis (using Synchro, HCM Cinema or other software as approved by the City Engineer), as well as time-space diagrams of the signal system. The study periods shall be the AM, midday and PM peak hours, although other time periods may be required. Signal timing optimization for a corridor may be required depending on traffic impact analysis.

### 8.2.3. Signal Spacing

Signalized intersections shall be located to maintain progression of traffic along arterial streets. This normally entails relatively uniform spacing and sufficient distances between signals to allow vehicles to travel at reasonable speeds. Optimal spacing of traffic signals is always the desire of the City. The optimal spacing is a function of the cycle length and the progression speed of traffic along the major street, but a general guideline is that signals should be placed at least a quarter of a mile apart. New signal locations shall be subject to spacing requirements on a case by case basis as determined by the City Engineer. Proposed signal locations not adhering to this spacing will be reviewed. The spacing requirements may be waived if the City Engineer determines that the proposed traffic signal will not significantly hinder the progression traffic along the major street. If the proposed location is rejected, the City Engineer may require either the relocation of the proposed signal location, to better accommodate progression, or the evaluation of other alternatives, for management of the traffic generated by the side street / private access.

#### **8.2.4. Private Benefit Signals**

Private benefit signals provide signalized access to private streets or developments. These signals are generally required when the property owners must improve access from their site onto the major street or facilitate movement between developments on opposite sides of the street.

(1) Required Installations: If the Traffic Impact Study for a new development indicates that a traffic signal will be warranted within 10 years of full build-out, the City Engineer may require the inclusion of a traffic signal as a part of the development plan. The financial responsibility for these signals shall be in accordance with the arrangements made during preparation of the development plan. The time frame for installation is dependent on the traffic projections and subject to the discretion of the City Engineer. The site development plans will not be approved until provisions for the installation of the traffic signal or other alternative measures to enhance the safe movement of traffic through the intersection are included in the plans.

#### **8.2.5 Designer Prequalifications**

The design of traffic signals shall be performed by the City or a qualified Engineer approved by the City. The design staff for any firm supplying traffic signal plans to the City must be familiar with the traffic signal design procedures used by the City. At the request of the City, the design engineer may be required to provide copies of their most recent traffic signal design and / or modification projects to the City Engineer prior to their being assessed as qualified.

#### **8.2.6 Intersection Design Study (IDS)**

An IDS must be prepared for any intersection that is proposed for the installation or modernization of traffic signals. Engineering work associated with the IDS will include topographical surveys, preparation of a base map, roadway geometric design, traffic signal layout and traffic signal phasing. The IDS shall include the traffic signal warrant study, detailed preliminary intersection and signalization design to meet present and future traffic needs, a list of needed rights-of-way, and a total project cost estimate suitable for budgeting purposes. An IDS that has been reviewed and approved by the City Engineer is required prior to the submittal of traffic signal plans for review. If an IDS does not exist for the intersection, one shall be prepared as part of the project presentation stage of design (described in the following section). If an IDS exists and, at the discretion of the City Engineer, the traffic conditions at the intersection have significantly changed since the preparation of the IDS, an update of the IDS may be required.

---

### **8.3 Design Standards**

#### **8.3.1 Referenced Standards**

The design of traffic signals is under the jurisdiction of the City and shall conform to the requirements and specifications outlined in this chapter. Traffic signal design on State highways in the city shall meet the requirements of the City as approved by TDOT. All traffic signal design shall conform to the requirements of the "MUTCD", "TDOT Standard Specifications" and "Special Provision Regarding Section 730f – Traffic Signals City of Franklin 730 General Requirements"

#### **8.3.2 Design Requirements:**

(1) **Internally illuminated Street Name Signs** - Temple Edge-Lit Internally-Illuminated LED Street Signs shall be installed on all mast arms. Signs shall have a Green Background and rigid mount back brace.

(2) **Radar Detection System** - Wavetronix detectors (Stop Bar and Advanced) complete with wiring and detector circuits for counting traffic shall be used on all approach lanes

except for exclusive right turn lanes that will operate with the associated through and/or left turn phases. In addition to stop bar and advance detectors in the thru lanes of moderate and/or high speed approaches (35 mph or greater), system detection shall be installed in the opposite direction thru lanes at the same location (subject to lane restrictions) as the advance loops.

### **(3) Signal Head Assembly**

- i. Shall be fabricated from cast aluminum. The signal housing shall be painted federal yellow (Signal housing in the Historic Downtown area shall be painted gloss black). Door faces shall be painted gloss black. Visors shall be constructed of sheet aluminum and the exterior painted gloss black. Visors shall be of the cutaway tunnel type. LED reflectors with polycarbonate lens shall be required.
- ii. Backplates shall be furnished and attached to the signal head. All backplates shall be louvered on each of the four sides of the panel, and fabricated from black ABS UV stabilized plastic sheet.
- iii. Bracket mounted signal heads shall be supported by mounting brackets consisting of assemblies of 1 ½" standard pipe size. All members shall be either plumb or level, symmetrically arranged, and securely assembled. Construction shall be such that all conductors are concealed within the poles and mounting assembly.
- iv. Signal indications on mast arms shall be aligned per "*TDOT Standard Specifications*".

**(4) Electrical Service Connection** - Underground service connection shall be installed per the Standard Drawings. The service pedestal shall be Milbank Model No. CP3B "SL" Series CP3B11110A22SL1.

**(5) Vehicle Detector (Infrared and GPS Activated Priority Control)** – All traffic signal installations shall include dual GPS/infrared Opticom emergency vehicle priority control system complete with detectors, wiring and card in the cabinet (3M system).

**(6) Cabinet / Controller** – The following shall be required for all traffic signals:

- i. The Cabinet shall be an Eagle ELS1014 size "P-UPS" base mounted cabinet with integrated UPS compartment. The UPS system shall be a Clary SPD2000 PD-N for rack mounting.
- ii. The Traffic Controller shall be an Eagle EPAC 3108-M52 with
- iii. A Fiber Connection Inc. "Gator Patch" Model # GP20Loo6FRB-xx-1 fiber optic distribution panel and drop cable shall be installed in the cabinet. (xx is cable length to splice pull box in meters).
- iv. NEMA Signal Monitor shall be Eberle Design Inc. SSM-12LEip Series.
- v. Surge Protector shall be EDCO ACP-340 (120 VAC – 1 Phase)
- vi. Loadswitch shall be Eagle Load Bays NEMA TS-1 TF4000 Series, with 16 load bay positions and 8 flash relay positions.

**(7) Pedestal Pole** – shall be powder coated black with a square pedestal base and installed per "*TDOT Standard Specifications*". Specialty poles and standards shall be required by the City Engineer in the Historic Downtown area.

## **(8) Cantilever Signal Support**

- i. Signal Support shall be Cantilever type and powder coated black. The installation of strain poles shall generally not be approved by the City and will be reviewed on a case by case basis by the City Engineer. Specialty poles and standards shall be required by the City Engineer in the Historic Downtown area.
- ii. Combination mast arms and other equipment necessary to provide intersection lighting will be required for all new traffic signal installations and modernizations. Aluminum and painted mast arm/signal poles, luminaire arms, and extensions shall be used.
- iii. Any street light luminaire extensions (aluminum and painted) shall be approved by the City Engineer. A minimum 30-foot luminaire mounting height and a minimum 15-foot luminaire arm (aluminum and painted) shall be used to mount the streetlight fixture. The attachment height for mast arm to pole shall be per approved shop drawings.

## **(9) Countdown Pedestrian Signal, Push Button Post, Button and Sign**

- i. All items shall be in compliance with "MUTCD" and ITE specifications.
- ii. Pedestrian signals and pushbuttons shall be provided at all signals unless otherwise directed by the City Engineer. All pedestrian signals shall have both audible and vibrotactile walking indications.
- iii. Yellow 16-inch LED countdown pedestrian signal with visor and a clamshell / banding mounting system are required, with ADA pedestrian buttons for all standard pedestrian movements with marked crosswalks (Pedestrian signal housing in the Historic Downtown area shall be painted gloss black). Housing material shall be one-piece die-cast aluminum alloy.
- iv. Pedestrian buttons shall be the bulldog type with audio alert, LED light, and sign housing/back plate. The accessible push button system with voice messages (APS) shall be used only where approved by the City Engineer.

**(10) Battery Back-up and Power Conditioner** – An uninterruptible power supply (U.P.S) shall be provided at all signals and shall be manufactured by Clary SP Series, Model PD, SP20000PD-N integrated PIM and Programmable Digital Display. Installation shall include SNMP Adapter SP-09G and outpost Batteries OP96SC-41

**(11)** Two 3-inch conduits (Schedule 40 PVC minimum) will be used for wiring between the signal bases and the cabinet.

**(12)** Pull box covers installed in the roadway shall meet or exceed TDOT specifications.

**(13)** Loop Lead-Ins shall be per "*TDOT Standard Specifications*" with the exception of provide a minimum 2-inch diameter conduit for better accessibility.

**(14)** Designer shall be required to include provisions for new streets and widening projects to include conduit for future signal interconnects and pull boxes as required.

**(15)** All shop drawings for signals are to be approved by the City Engineer prior to installation.

### 8.3.3 Traffic Signal System Requirements

- (1) The installation of a fiber optic interconnect is required between signalized intersections that are within 1/2 mile of one another or if analysis indicates that the signals would benefit from signal coordination. Communications interface must be installed as a part of the project if one does not exist already. All traffic signal systems will use IP based communications protocols and equipment shall have IP addressable ports.
- (2) The City Engineer may require the installation of detection for the purpose of collecting traffic counts.

### 8.3.4 Electrical Requirements

- (1) The traffic signal design shall conform to the National Electric Code.
- (2) Traffic signal equipment shall conform to NEMA standards.
- (3) Fiber optic interconnect shall include a copper tracer, pull string/jet line, marker tape and curb markers in all ITS conduit.
- (4) Power back up shall be provided at locations required by the City Engineer, with the ability to provide stop-and-go control for up to one hour.
- (5) The traffic signal plan shall include a continuous grounding plan for the intersection.
- (6) Double hand holes are required at all traffic signal cabinet locations.
- (7) Power disconnects shall be provided.
- (8) New power installations shall be continuously metered by MTEMC.
- (9) Service pedestals shall contain circuits and test switches for safety lighting and illuminated street name signs.

### 8.3.5 Construction

Traffic signal installations / modernizations shall be constructed in accordance with applicable sections of the "TDOT Standard Specifications".

### 8.3.6 Materials and Construction Notes

The specifications for traffic signal equipment and related appurtenances required by the City are maintained by the Engineering Department. A copy of these specifications is included and subject to change by the City Engineer.

### 8.3.7 Pedestrian Signals and Timings

The "MUTCD" identifies the situations in which pedestrian signal shall be used and the situations in which pedestrian signals shall not be used. Because one should assume that pedestrians will be present at all intersections in the City to some level, all signalized intersections shall be designed to accommodate pedestrians. Other locations that have high pedestrian volumes with marked crosswalks may also warrant the installation of a dedicated pedestrian actuated traffic signal, subject to review and approval by the City Engineer.



Bicyclists are required to follow the rules of the road, including those related to traffic signals. Therefore, signal timing and detection shall accommodate the needs of bicyclists. Traffic signal clearance intervals are recommended to be timed to provide bicyclists with sufficient time to react, accelerate, and proceed through an intersection on the clearance interval. Normally, a bicyclist can travel through an intersection under the same signal phasing arrangement as motor vehicles. However, special consideration of bicyclists' needs may be necessary at multi-lane crossings and at acute angle intersections, which take longer to cross. The clearance interval shall take into consideration a bicyclist's speed of 6-8 MPH, and a perception/reaction/braking time of one (1.0) second. Traffic detectors for traffic-actuated signals are recommended to be set to detect bicycles.

There are various types of detector loops that can be used for bicycle lanes. Quadruple and diagonal quadruple loop detectors generally provide for bicycle detection, unlike standard loops, which are difficult to adjust to detect bicycles. Detectors shall be located in the bicyclist's expected path of travel. When bicycle lanes are not present, pavement markings shall be used to indicate where bicyclists should position themselves in order to activate the signal detector.

The "MUTCD" and "PROWAG" standards shall be consulted regarding pedestrian signal timings. However these documents contain some differences. Each of these documents shall be reviewed, and the most stringent requirements shall be applied when designing pedestrian signal timings.

---

## 8.4 Signal Phasing and Timing

### 8.4.1 Purpose

The City has adopted a set of traffic signal timing and phasing guidelines which are to be implemented at signalized intersections under their jurisdiction. The purpose of these guidelines is to establish standard practices and operational procedures for traffic signal timing parameters to be used by City staff and consulting engineers performing signal timing services for City. This policy is in no way in conflict with "MUTCD". Should a conflict arise, the "MUTCD" shall prevail.

The guidelines in this document are to be implemented at new traffic signal installations, traffic signal upgrades, and along signalized corridors as they are re-timed. The adoption of these guidelines does not imply that each and every traffic signal under the jurisdiction of the Engineering Department will automatically comply with these new guidelines. Rather, traffic signal settings will be updated along signalized corridors throughout the City as they are retimed.

These guidelines have been established to provide guidance on various signal timing parameters. However, signal timing shall be evaluated for all situations independently based upon standard traffic engineering principles and local intersection characteristics. Necessary adjustments shall be made to meet the traffic conditions at each individual signalized intersection. These guidelines should serve to provide consistent, safe, and efficient control of traffic signals within the City.

### 8.4.2 Vehicle Clearance Intervals

The "MUTCD" requires that vehicle clearance intervals consist of a required yellow change interval and an optional red clearance interval. The "MUTCD" defines both the yellow change and red clearance intervals as:

*Yellow Change Interval – the first interval following the green interval during which the yellow signal indication is displayed.*

*Red Clearance Interval – an optional interval that follows a yellow change interval and precedes the next conflicting green interval.*

The timing of Yellow Change and Red Clearance intervals are to be established per the ITE Recommended Practice.

#### **8.4.3 Pedestrian Control Features**

There are a number of pedestrian-related items that are covered in this portion of the guidelines. They include recommended pedestrian walking speeds, minimum pedestrian walk intervals for pedestrian signal phasing, guidelines for pedestrian clearance intervals. The City adheres to "MUTCD" recommended standards for pedestrian timing.

#### **8.4.4 Pedestrian Push Button Usage**

Pedestrian push button actuation is recommended for pedestrian phases that cross the 'main street' approaches so that 'side street' vehicle phases do not have to accommodate pedestrian timings unless they are actuated via a pedestrian push button. The need for push button actuation to cross side street approaches shall be determined via engineering judgment by the City. For the purposes of determining main street approaches in reference to pedestrian timings, the main street approaches will be considered the signalized approaches that are coordinated and are therefore non-actuated. If a traffic signal is pre-timed or fully-actuated, the differentiation between main street and side street does not apply for this situation.

#### **8.4.5 Walk Rest Modifier Option**

During main street vehicle signal phases that are non-actuated, there are often situations where the vehicle split is significantly larger than the required pedestrian walk and clearance intervals. Rather than increasing the pedestrian clearance interval to accommodate the additional time available, City staff will allow the signal controller to extend the length of the pedestrian walk interval. There are however, situations where this option, known as the walk rest modifier, should not be allowed. Such applications where the walk rest modifier should not be utilized include the following: (a) cases where right-turn volumes are heavy across the pedestrian crossing area, (b) cases where permissive left-turn volumes are heavy across the pedestrian crossing area, and (c) any other cases where City staff has determined that the walk rest modifier option should not be implemented.

#### **8.4.6 Minimum Vehicle Green Times**

Minimum vehicle green times shall be short enough so that green time is not wasted, yet not so short such that motorists unexpectedly see the yellow change interval while entering the intersection and become confused. The minimum times documented in this section of the policy are the minimum allowed which does not suggest that all signalized intersections will utilize these minimum values. Greater minimum green times are allowed; however values lower than these mentioned below are not recommended. In addition, the percentage of trucks shall also be reviewed on an intersection-by-intersection basis since a high percentage of trucks may necessitate increasing the minimum green time controller setting. Maximum green time setting are not discussed in this policy since they vary significantly by location and are based on signal operation, vehicle demand, and other operational characteristics.

Minimum Green Times for Left-turn Phases - A minimum green time setting of five (5) seconds is allowed for left-turn phases.

Minimum Green Times for Side Street Through Phases - A minimum green time setting of seven (7) seconds is allowed for side street phases.

Minimum Green Times for Main Street Through Phases - A minimum green time setting of ten (10) seconds is allowed for main street through phases.

#### **8.4.7 Main Street and Side Street Definitions**

It is often obvious, when comparing approach geometry, traffic volumes, road classification and/or route continuity, which roadway is considered the 'main street' and which is considered the 'side street'. However, there are instances where there is no clear cut distinction between the two. Some intersections include two main streets. For the purposes of selecting minimum green time settings, the City Engineer will apply the above factors in determining whether or not a main street approach exists.

#### **8.4.8 Left-Turn Signal Phasing Guidelines**

Left-turn phasing guidelines as discussed in the ITE *Traffic Engineering Handbook* are to be used for assistance in assessing the need for left-turn phasing at signalized intersections under City jurisdiction. There are two Transportation Research Record documents suggested by ITE for traffic engineers to consider when determining the need for some form of protection for left turn phases. They are:

From J. E. Upchurch. Guidelines for Selecting Type of Left-turn Phasing. In *Transportation Research Record* 1069, Transportation Research Board, National Research Council, Washington, D.C., Figure 5, p. 37.

From Asante, S. A., S. A. Ardekani, and J. C. Williams. Selection Criteria for Left-Turn Phasing and Indication Sequence. In *Transportation Research Record* 1421, Transportation Research Board, National Research Council, Washington, D.C., 1993, Figure 4, p. 17.

These guidelines shall be used as a tool for determining the need for left-turn phasing at signalized intersections along with engineering judgment by the traffic engineer.

In addition to the guidelines referenced above, there are two additional guidelines that are to be adopted as City policy:

- (1) Exclusive/permissive left-turn signal phasing is allowed when three (3) opposing through lanes exist as long as there is no accident experience problem and/or sight distance issue that would hamper the safety of permissive left-turn movements.
- (2) Exclusive left-turn signal phasing shall be installed where multiple left-turn lanes exist.

#### **8.4.9 Protected/Permissive Left-Turn Phase Operation**

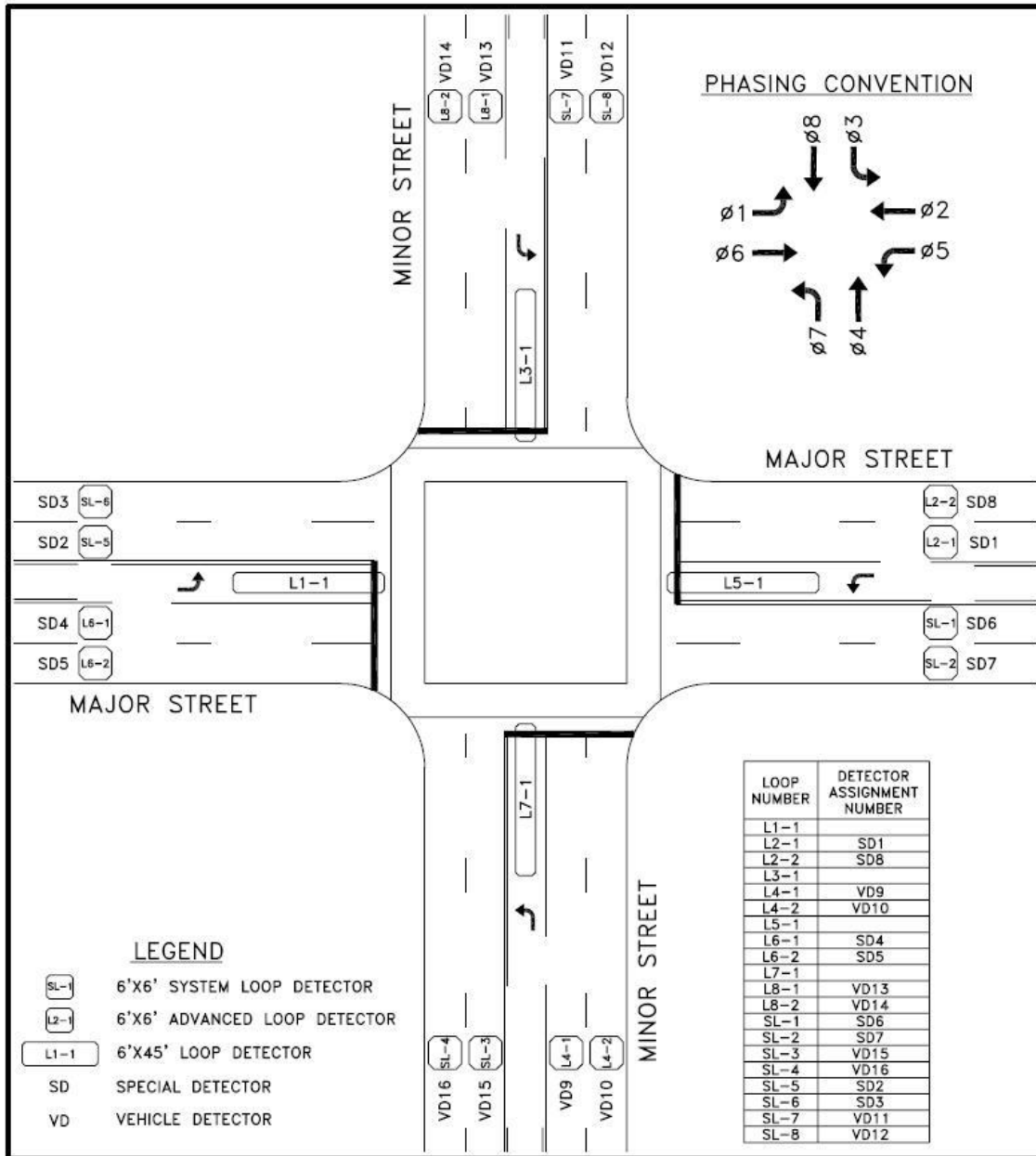
Phasing for eight-phase signal controllers shall prohibit a phase change from main street green to a main street left-turn phase if the left-turn phase operates protected/permissive. In the absence of a side street actuation, the signal controller shall remain in main street green to allow left-turn movements to occur on the permissive green.

Where left-turn delay and/or safety problems exist, the City may investigate and apply the flashing Yellow Arrow (FYA) protected/permitted signal display, in accordance with the guidelines described in the "MUTCD". All such installations shall provide the regulatory signs as required in the "MUTCD". City Engineer approval shall be required for the FYA.

#### **8.4.10 Split-Phase Timing Operation Guidelines**









The term split-phase signal operation describes a signal phasing sequence where one approach is given exclusive right-of-way into the intersection followed by the opposing approach being provided exclusive right-of-way into the intersection. This operation eliminates left-turn conflicts; however, it is often described by traffic engineers as an inefficient signal phasing option since the entire intersection is given a red indication to service only one of the four signalized approaches. The City Engineer may require intersection upgrades to remove split-phase operations to improve or maintain level of service. For traffic signals under the jurisdiction of the City, the following situations may necessitate the need for split-phase timing operation:

- (1) Where offset approaches exist that may cause motorist conflicts/confusion if permissive phasing were implemented.
- (2) Where intersection width prevents opposing left turn movements from operating concurrently. The City Engineer may require intersection upgrades to correct the opposing left turn movements. Prior to implementing split-phase operation due to this geometric limitation, the installation of lead-lag phasing shall also be considered.
- (3) When an accident problem exists between left-turn and through movement conflicts that has not been successfully remedied via other operational improvements.
- (4) Where a sizeable volume imbalance exists on the side street approaches.
- (5) Where a second left-turn lane is needed but must be shared with a through movement lane. The City Engineer may require intersection upgrades to correct this issue and maintain adequate level of service.
- (6) Where the need to serve the left-turn volume is relatively close to the time needed to serve the through movement volume. For each case, a capacity analysis shall be performed comparing split-phase timing operation versus other signal phasing options prior to implementation.











Typical Detector Numbering and Phasing Convention

## PHASING MAP FOR NORTH/SOUTH MAIN STREET

Phase 1 – NBLT	Phase 2 – SB Thru	Phase 3 – EBLT	Phase 4 – WB Thru
			
Phase 5 – SBLT	Phase 6 – NB Thru	Phase 7 – WBLT	Phase 8 – EB Thru
			

## PHASING MAP FOR EAST/WEST MAIN STREET

Phase 1 – EBLT	Phase 2 – WB Thru	Phase 3 – SBLT	Phase 4 – NB Thru
			
Phase 5 – WBLT	Phase 6 – EB Thru	Phase 7 – NBLT	Phase 8 – SB Thru
			

### 8.4.11 Leading/Lagging Left Turn Operation

Leading/Lagging Left Turn operation shall be considered as an option for signal operation. It must consistently operate in the same mode throughout the day. Leading and lagging assignments may not be changed by time-of-day.



# STREET LIGHTS

Section	Section Title	Article	Article Title	Pg
9.1	Introduction			9-2
9.2	Definitions			9-2
9.3	Ownership / Responsibilities	9.3.1	Responsibilities Delineated	9-2
9.4	Design Guidelines	9.4.1	General Design Standards	9-3
		9.4.2	Local, Private, and Minor Collector Streets	9-8
		9.4.3	Major Collector and Arterial Streets	9-10
		9.4.4	Submission Requirements	9-10
		9.4.5	Light Levels	9-10
9.5	Record Drawings			9-10
9.6	City of Franklin Approved Street Light Options			9-10

## 9.1 Introduction

Adequate lighting shall be provided to ensure safe movement of persons and vehicles in the public right-of-way, and to assist for security purposes. The primary purpose of street lights is to illuminate the public traveled ways to a level and uniformity that provides for the safe passage of public traffic, both vehicle and pedestrian.

---

## 9.2 Definitions

**COF:** City of Franklin

**LEED:** Leadership in Energy and Environmental Design

**LED:** Light Emitting Diode

**MTE:** Middle Tennessee Electric Membership Corporation: Cooperatively owned electric power distributor for the 4-county area of Williamson, Wilson, Rutherford, and Cannon counties of Tennessee.

**Street Light:** A raised source of light on the edge of a street or walkway, which is turned on or lit at a certain time every night.

**Street Lighting System:** A series of street lights within the same development or project.

**IES:** Illuminating Engineering Society of America.

---

## 9.3 Ownership / Responsibilities

In general, street lighting for public and private streets shall be owned and operated by MTE. Street lighting for streetscape in downtown historic Franklin gateway corridors shall be owned and operated by the City of Franklin.

### 9.3.1 Responsibilities Delineated

#### (1) Developer/Property Owners' Association/Contractor Responsibilities:

- (a) Submit lighting plans for approval by the City of Franklin.
- (b) Obtain a City of Franklin electrical permit for City or Privately owned and operated street lights.
- (c) Obtain MTE approval for street lighting systems that are to be owned and operated by MTE.
- (d) Responsible for utility initiation charges and energy usage charges until City accepts ownership.
  - i. Ownership for private development project occurs at the time the City of Franklin releases all performance sureties. The Franklin Municipal Planning Commission (FMPC) must approve the lighting of the City owned part of the projects prior to turn-over to maintenance and billing.



- ii. Ownership for City capital projects occurs at the time the entire project is substantially complete and accepted by the City.

**(2) City of Franklin (COF) Responsibilities:**

**(a)** COF shall review and approve all street lighting through appropriate submittals in accordance with Site Plans, PUD Development Plans, Preliminary Plats, Final Plats, Infrastructure Plans, Lighting Plans, and Lighting Calculations.

**(b)** COF shall inspect, review and approve final record drawings associated with the record lighting plans.

i. MTE owned and operated street lights:

- COF shall inspect street light locations as shown on the City approved construction documents.
- COF shall coordinate with MTE to specify the billing rate class for the new street light services.

ii. COF owned and operated street lights

- COF shall inspect conduit pole bases.
- COF shall perform scheduled ditch/conduit inspections before ditches are closed.
- COF shall perform scheduled foundation inspections before concrete is poured.
- COF shall perform electrical inspections on the customer side of the meter.
- COF shall perform final inspections before lights are connected to the MTE system.

---

## 9.4 Design Guidelines

Street lighting systems will be implemented in such a way as to improve the development in which the system is serving. The specifics of each street light will be reviewed by the City, as outlined herein, to ensure that any proposed street light will enhance its surroundings and improve public safety while also optimizing energy efficiency and cost savings. The City of Franklin has adopted the following basic lighting standards.

### 9.4.1 General Design Standards

All street lighting of public and private streets in the City shall be designed in accordance with these standards. Adjacent bikeways and pedestrian ways are to be included when associated with the public right-of-way.

#### **(1) Underground Electric Service**

Street lighting shall be installed with underground electric service on all newly developed dedicated public streets in the City. Curb returns shall be installed after the installation of the electrical system, including underground vaults. The Developer is responsible for coordinating with MTE for all aspects of electrical service.

#### **(2) Fixture Type**

All luminaires shall have a LED light source with a color temperature as approved by MTE. The city seeks to minimize light pollution and avoid distributing light into windows of residents. All fixtures shall include cutoff shields or other mechanisms so that light levels outside of the right-

of-way does not exceed levels stipulated by LEED for the lighting zone of the project. No luminaries shall have any blinking, flashing or fluttering lights or other illuminating device which has a changing light intensity, brightness or color, nor is any beacon light permitted, except those required for fire alarm and/or emergency systems.

### **(3) Fixture Location**

- (a)** The final installation location and quantity of all street lights shall be determined by detailed calculations, coordination with the site during design and approved by the City Engineer.
- (b)** Poles may be located within landscaped areas or islands; however, to avoid conflicts with required trees, the location of poles shall yield to existing mature trees. Proposed trees shall be relocated to avoid conflicts with light standards.
- (c)** Unless otherwise approved by the City Engineer or their designee all street lighting equipment conduits and foundations shall be located in the street right-of-way.
- (d)** When locating proposed lighting, the designer shall avoid possible conflicts with above-ground and below-ground utilities.

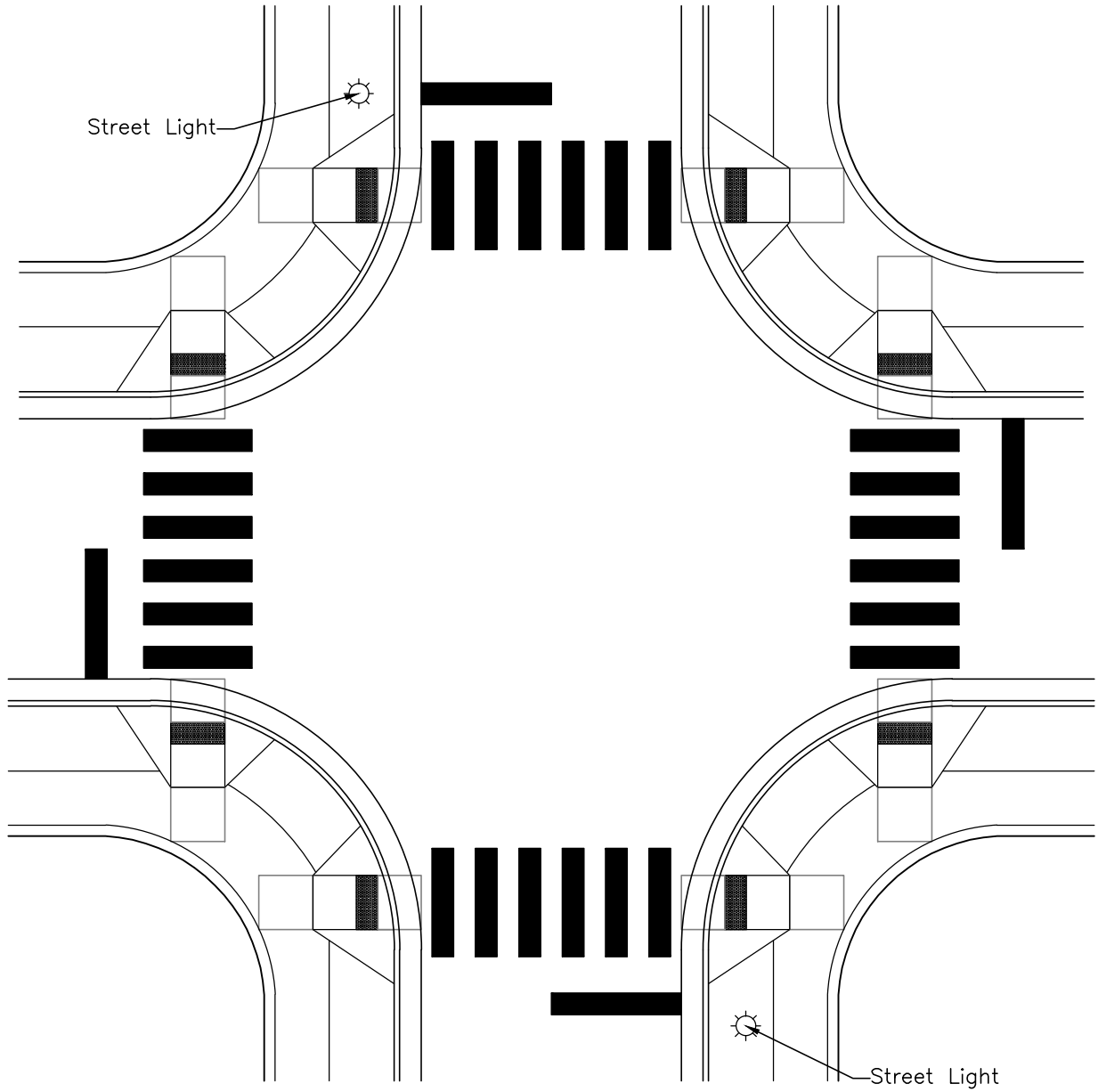
### **(4) General Layout Criteria**

- (a)** A minimum of two lights shall be placed at every non-signalized street intersection, with the exception of non-signalized street T-intersections, alleys, and mews. Non-signalized street T-intersections, alleys, and mews require only one light at the intersection. (See **Figure 9.4(1) and 9.4(2)**)
- (b)** Signalized intersections may be lighted using combined street lights and/or lighting located on the signal mast arms. A minimum of four lights shall be placed at every signalized intersection.
- (c)** Roundabout lighting shall be in accordance with recommendations of IES DG-19-08 "Design Guide for Roundabout Lighting." Lighting shall make roundabout visible from a distance, and make key conflict areas more visible. If continuous roadway lighting is not present, transition lighting is to be provided.
- (d)** Railroad crossing lighting will conform to the latest version of the Railroad-Highway Grade Crossing Handbook (FHWA) and the Lighting Handbook (FHWA). If considered a conflict, luminaire supports shall be placed in areas of accessibility. Where placed in the clear-zone of a high speed road, they shall have a break-away base.
- (e)** All bridge underpasses, where vehicles, pedestrians, bicyclists, or equestrians may be present, shall require lighting.
- (f)** Where sidewalks are attached to the curb, street lights shall be installed behind the sidewalk (in right-of-way or easement) with at least one (1)-foot clearance on Local streets (two (2) feet clearance on Major Collectors and Arterials). Poles within the clear zone shall be breakaway designs.
- (g)** For sidewalks detached from the curb, street lights shall preferably be located between the curb and sidewalk and installed a minimum of two (2) feet from the back of curb, and two

(2) feet clear from all walks (one (1)-foot on Local Streets). Poles within the clear zone shall be breakaway designs.

**(h) Non-Curbed Streets** - On streets without curb and gutter, street lights shall be place no closer than ten (10) feet to the edge of the traveled way. Poles within the clear zone shall be breakaway designs.

**(i) Street Lighting in Medians** - Street trees shall not be placed within 30 feet of a street light. Understory trees shall be no closer than 15 feet to any street light. Poles within the clear zone shall be breakaway designs.



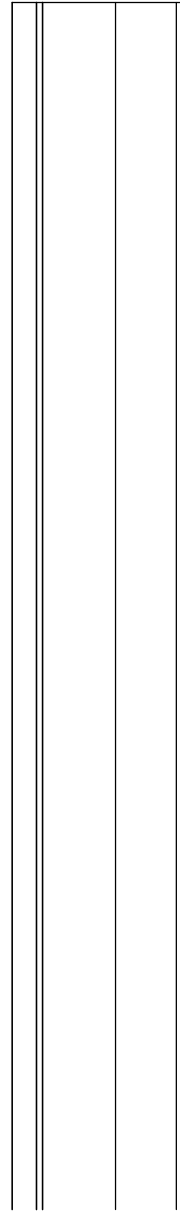
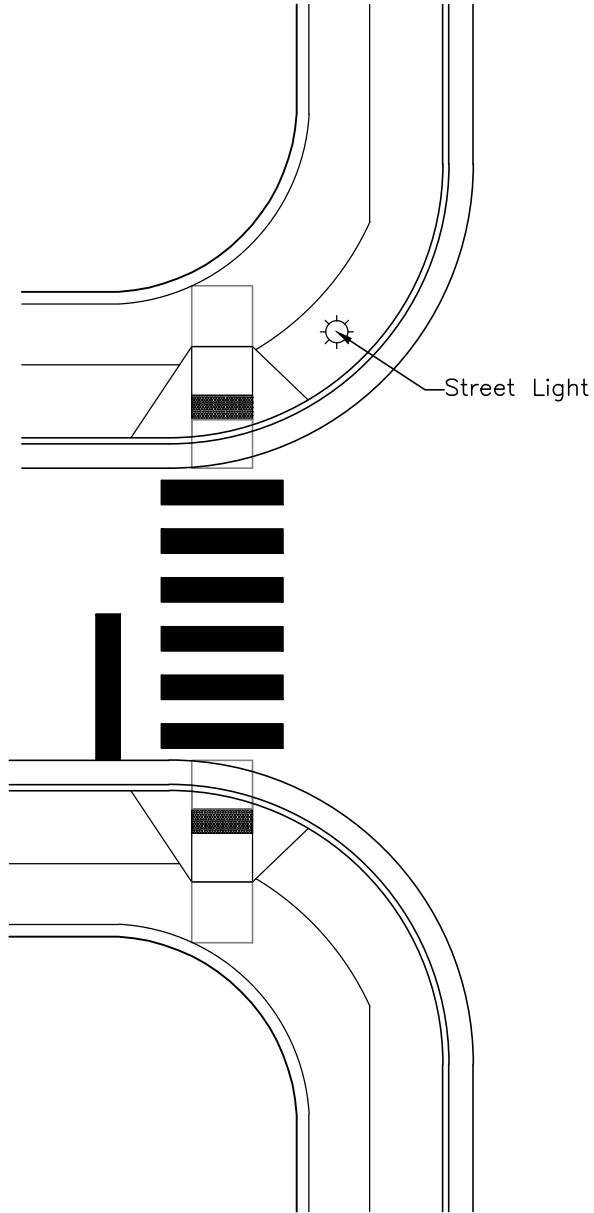
Street Light

Street Light

N.T.S

FIGURE 9.4 (1)  
NON-SIGNALIZED INTERSECTION PRESCRIPTIVE LIGHTING





#### **9.4.2 Local, Private, and Minor Collector Streets**

In addition to the General Design Standards, all street lighting on local, private, and Minor Collector streets shall be LED and installed per MTE standard drawings. MTE shall be responsible for operation and maintenance.

Energy cost associated with lighting on public streets shall be the responsibility of the City of Franklin, TN.

Energy cost associated with lighting on private streets shall be the responsibility of an association of the development.

##### **(1) Prescriptive Lighting Standards**

All local, private, and Minor Collector streets shall have prescriptive lighting based on the following standards:

(a) Max Spacing of light poles shall not exceed 300 feet with a clear line of sight within the ROW from one pole to the next (excluding landscaping). (See **Figure 9.4(3)**)

(b) Street lighting shall be placed in every cul-de-sac and dead-end streets (Temporary or permanent). (See **Figure 9.4(3)**)

(c) Street lights shall be placed thirty (30) inches from curb face to center, in line with trees in the furnished zone between the sidewalk and the curb.

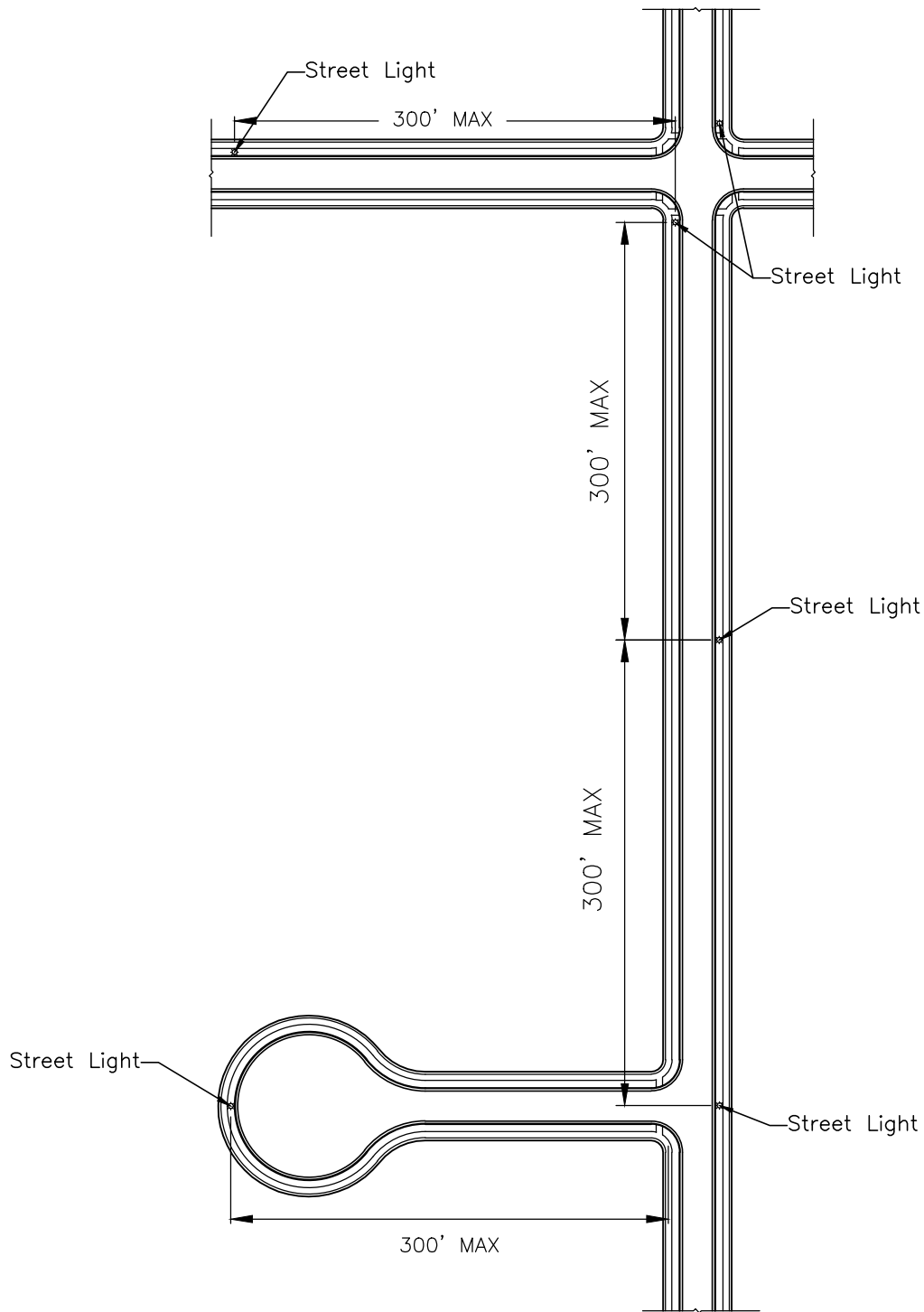
(d) Poles shall be placed a minimum of ten (10) feet from driveway aprons.

(e) Street light poles and foundations shall not be located over any other utilities. When locating proposed lighting, the designer should avoid possible conflicts with above-ground and below-ground utilities.

(f) Street light poles shall be located along lot lines whenever possible.

(g) Street light mounting height shall be limited to 16 feet above finished grade.

Upon the request of any owner of property to which this subsection applies, the City Engineer may approve an alternative prescriptive lighting plans. In making this determination, the City Engineer may consider specific design constraints such as large lot subdivisions.



N.T.S

FIGURE 9.4 (3)  
LOCAL AND PRIVATE STREET PRESCRIPTIVE LIGHTING



### 9.4.3 Major Collector and Arterial Streets

In addition to the General Design Standards, street lighting on Major Collector and Major and Minor Arterial streets shall meet the standards set forth in the *Recommended Practice for Design and Maintenance of Roadway and Parking Facility Lighting (ANSI/IES RP-8)*, latest edition issued by the American National Standards Institute, ANSI, and the Illuminating Engineering Society, IES, and related documents therein. The RP-8 is considered a live document, and any supplemental revisions are to be adhered to unless otherwise directed by the City Engineer.

Trespass light shall be limited to values defined by LEED and shall be based on the lighting zone of the project. Lighting zones shall be as adopted by the IES to describe the ambient lighting conditions/sensitivity of the area.

### 9.4.4 Submission Requirements

The following documentation shall be submitted for City of Franklin review and approval prior to approval of site plan or infrastructure plan.

#### (1) Lighting Plan

- (a) Location, type, and height of all lighting
- (b) Clearly identified/labeled property lines, streets and sidewalks.

### 9.4.5 Light Levels

Lighting shall be designed to the recommendations of the Illuminating Engineering Society of North America for levels, uniformity, and veiling luminance. The illuminance/luminance shall take into account the roadway surface classifications (R-class). For most cases, the R2 and R3 classes will be acceptable.

---

## 9.5 Record Drawings

Project applicant or designee shall provide record drawings that depict construction to the City prior to the request for City to acceptance.

---

## 9.6 City of Franklin Approved Street Light Options

- (1) **Downtown Historic Franklin** – See approved COF streetscape lighting fixtures.
- (2) **All Other Streets** – See MTE LED street light standards.






---

## TRAFFIC SIGNS AND MARKINGS

Section	Section Title	Article	Article Title	Pg
10.1	Signing	10.1.1	Type and Location of Signs	10-2
		10.1.2	Design, Installation, and Maintenance	10-2
		10.1.3	Sight Visibility Standards for Traffic Control Signs	10-2
		10.1.4	New Street Signing	10-2
		10.1.5	Other Standards	10-2
		10.1.6	Sign Posts, Supports, and Mountings	10-2
		10.1.7	Sign Reflectivity	10-3
		10.1.8	Sign Blanks	10-3
10.2	Pavement Marking and Striping	10.2.1	Type and Location of Striping and Markings	10-3
		10.2.2	Design, Installation, and Maintenance	10-3
		10.2.3	Crosswalks	10-4

## 10.1 Signing

### 10.1.1 Type and Location of Signs

The City Engineer shall make the final determination regarding the type and location of signing controls within the right-of-way. These controls shall include traffic control signs (regulatory and warning), street name signs, delineators, and permanent barricades.

### 10.1.2 Design, Installation, and Maintenance

Permanent traffic control devices on public rights-of-way and private streets shall be fabricated and installed in accordance with this chapter, the latest revision of the "MUTCD" and "TDOT Standard Specifications".

Bicycle facilities shall be designated with signing. AASHTO's "Guide for the Development of Bicycle Facilities" and the "MUTCD" shall be consulted in order to determine appropriate signing for new bicycle facilities. Signs should be used in moderation in order to avoid distracting street users. When signs are used, they shall be highly visible and easily understood by all street users. Signs that are directed at bicyclists are smaller versions of standard street signs. This is because bicyclists typically travel at slower speeds than motorists and are typically closer to the signs than motorists are. Standard street signs that are directed at motorists also apply to bicyclists.

### 10.1.3 Sight Visibility Standards for Traffic Control Signs

These standards are to provide for tree placement and configuration of City streets such that adequate sight distance is provided for traffic control signs. Typical sign types include but are not limited to mid-block warnings, speed limit signs and stop signs. Minimum sight distance required by AASHTO "A Policy On Geometric Design of Highways and Streets", shall be provided but shall not be less than:

- (1) On streets designated at speed limit 20 MPH or 25 MPH, the first tree in front of the sign is to be placed a minimum of forty-five (45) feet before the sign.
- (2) On streets designated at speed limit 30 MPH, the first tree in front of the sign is to be placed a minimum of sixty (60) feet before the sign.
- (3) On streets designated at speed limit 40 MPH, the first tree in front of the sign is to be placed a minimum of seventy-five (75) feet before the sign.
- (4) For trees exceeding ten (10) feet of canopy vertical clearance from the ground, the first tree in front of the sign is to be placed a minimum of twenty-five (25) feet before the sign.
- (5) Where signs are placed at the front end of curb extensions or bulb-outs, the above tree placements do not apply.

### 10.1.4 New Street Signing

Permanent signing, unless otherwise approved by the City Engineer, shall be completely in place before any new street is opened to the public.

### 10.1.5 Other Standards

These Standards are to be used in conjunction with other applicable City Regulations. The City Engineer may allow the installation of decorative posts and sign frames. In these cases, the developer, homeowners' association or other responsible entity shall be responsible for the maintenance of these special installations. Decorative traffic supports, whether city-provided or developer-provided shall be black or dark green in color.

#### **10.1.6 Sign Posts, Supports, and Mountings**

Sign posts, supports and mountings shall comply with "TDOT Standard Specifications". In general, a 2-inch 12 gage square galvanized steel post section with perforated knockout tubes shall be the Cities standard for ground mounted signs. All other signs shall be per "TDOT Standard Specifications" and reviewed on an individual basis. Posts must be of appropriate length to comply with the "MUTCD" and "TDOT Standard Specifications".

#### **10.1.7 Sign Reflectivity**

All traffic control signs must be fabricated with reflective materials. All reflective materials must qualify as High Intensity Grade for all signs except those signs for schools, pedestrians and overhead street name blades. For these signs, Diamond Grade sheeting shall be used. All signs or traffic control devices must have a minimum 7-year materials warranty.

#### **10.1.8 Sign Blanks**

Aluminum blanks of 0.080 gauges are standard, except for signs larger than 30 x 30 inches, which shall be 0.125-gauge aluminum.

---

## **10.2 Pavement Marking and Striping**

#### **10.2.1 Type and Location of Striping and Markings**

The City Engineer shall make the final determination in regards to the type and location of pavement striping and marking within the right-of-way during the review of the project signing and striping plans. All pavement marking on public and private roadways shall be specified and installed in accordance with these Standards; all designs shall be in accordance with these Standards, the "MUTCD" and "TDOT Standard Specifications". Permanent pavement line striping shall typically be four (4) inches wide, except on State Routes or Arterial Streets which shall be six (6) inches wide, unless otherwise approved by the City Engineer.

Bicycle facilities shall be designated with pavement markings. AASHTO's "Guide for the Development of Bicycle Facilities" and the "MUTCD" shall be consulted in order to determine appropriate pavement markings for new bicycle facilities. A bike lane shall be separated from motor vehicle travel lanes by a solid white line that is six (6) inches wide. The width of this line can be increased to eight (8) inches for added distinction. If on-street parking is present, a four (4) inch wide solid white line shall be used to separate the bike lane from the parking lane.

#### **10.2.2 Design, Installation, and Maintenance**

Permanent striping and marking, unless otherwise approved by the City Engineer, shall be completely in place before any new street is opened to the public. For streets opened to traffic prior to final surfacing and striping, the use of reflectorized paint installed to permanent standards at the end of each day's work shall be allowed. In addition, pavement markings shall be updated as needed to comply with "TDOT Standard Specifications" and "MUTCD" standards.

Thermoplastic pavement markings shall be used on all public and private streets within the City of Franklin. New striping on new streets, overlays, and chip seals, etc. will require Extruded or Ribbon-Dispensed Thermoplastic Pavement Markings. Spray Thermoplastic Markings will be evaluated on a case by case basis by the City Engineer. As an alternate, the Contractor may apply preformed thermoplastic markings material for stop bars, cross walks, legends, or directional arrows. Snowplowable raised pavement markers shall be provided on state routes within the City. All pavement markings shall be installed per "TDOT Standard Specifications".

Permanent striping and marking on the roadway centerline shall be installed on each segment of roadway construction on the same day the final lift of asphalt concrete pavement is placed on that roadway segment. New traffic striping of lane lines, crosswalks, and stop bars (skip white and solid white) shall be installed on each segment of roadway construction within one Calendar Day of the final lift of asphalt concrete pavement placed on that roadway segment.

### **10.2.3 Crosswalks**

Crosswalks shall be used at all signalized intersections, approved crossings, school routes, adjacent to schools, and as otherwise directed. Mid-block crosswalks shall be approved on a case-by-case basis subject to an engineering study as approved by the City Engineer. Standard Crosswalk Configuration shall consist of a 10-foot minimum width and 24-inch wide "Continental" style bars and shall be used for all crosswalks unless otherwise approved by the City Engineer. Where concrete pavement is present, the specific manufacturer's primer must be applied as per manufacturer's specifications.

# GLOSSARY

AASHTO: American Association of State Highway and Transportation Officials.

ACCESSIBLE PEDESTRIAN SIGNAL (APS): A device that communicates information about pedestrian timing in non-visual format such as audible tones, verbal messages, and/or vibrating surfaces. (MUTCD)

ACCESS EASEMENT: A publicly owned area of land granted by adjacent landowners or reserved as part of a development plan and being part of the City right-of-way for the purpose of accessing public improvements for maintenance.

ACTUATED OPERATION: A type of traffic control signal operation in which some or all signal phases are operated on the basis of actuation. (MUTCD)

ACTUATION INDICATOR: Either a light, a tone, a voice message, or both audible and visual indicators that indicate to pedestrians that the button press has been accepted.

ACTUATION: Initiation of a change in or extension of a traffic signal phase through the operation of any type of detector. (MUTCD)

ALERT TONE AT ONSET OF WALK INTERVAL: A very brief burst of high frequency sound, rapidly decaying to a 500 Hz WALK tone, to alert pedestrians to the exact onset of the walk interval.

APPROACH: The portion of an intersection leg which is used by traffic approaching the intersection

APS: See Accessible pedestrian signal.

ARMY CORPS OF ENGINEERS: Provides engineering services as a government agency as it relates to civil engineering projects.

AUDIBLE BEACON: Use of a sound source to provide directional orientation and alignment information.

AUTOMATIC VOLUME ADJUSTMENT: An APS volume control that is automatically responsive to ambient (background) sound; automatic gain control.

AUXILIARY LANE: The portion of a street adjoining the traveled way for parking, speed change, turning, weaving, truck climbing and other purposes supplementary to through traffic movement.

AVERAGE DAILY TRAFFIC (ADT): The total bi-directional volume of traffic passing through a given point during a given time period (in whole days), divided by the number of days in that time period.

**BICYCLE PLAN:** Plan initiated by the City to promote multi-modal transportation and to provide safe and accessible facilities for bicycles and pedestrians. Standards address design features of bicycle facilities.

**BOMA:** Board of Mayor and Alderman

**BRAILLE STREET NAME:** Provision of the name of the associated street in Braille above the APS pushbutton.

**BUTTON ACTUATED TIMER (BAT):** See Extended button press.

**CAPACITY:** The maximum hourly rate at which persons or vehicles can reasonably be expected to traverse a point or uniform segment of a lane or roadway during a given time period under prevailing traffic, roadway and control conditions.

**CITY STANDARDS & SPECIFICATIONS:** Those standards prescribed for the construction of streets, sidewalks, driveway access points, curb and gutter set out in this manual and the City Code.

**CITY:** The City of Franklin, TN

**CITY ENGINEER:** A licensed professional engineer employed by the City or his duly authorized representative serving to direct and oversee engineering design, coordination and implementation of private and City capital improvements as well as public safety and welfare. All places within these Standards that reference the City Engineer shall refer to the City of Franklin, Tennessee City Engineer or their designated representative.

**CLEARANCE INTERVAL INDICATOR:** Tones sounding during the pedestrian clearance interval that are differentiated from the walk interval indicator (tones).

**BUILDING AND NEIGHBORHOOD SERVICES DIRECTOR:** City official responsible for directing the enforcement and interpretations of the provisions of national and local building codes.

**COMMERCIAL DRIVEWAY ACCESS:** Any driveway access point that does not meet the definition of residential driveway access.

**CONNECTIVE STREET:** A street within a development, other than a cul-de-sac street or loop street, which will allow vehicular and pedestrian circulation to adjoining developments; thereby providing for community-wide circulation.

**CONTROLLER UNIT:** That part of a controller assembly that is devoted to the selection and timing of the display of signal indications. (MUTCD)

**CORNER CLEARANCE:** At an intersecting street, the distance measured from the edge of pavement curb line or the intersection of right-of-way lines to the beginning of outside driveway radius.

**CROSSWALK.:** (a) that part of a roadway at an intersection included within the connections of the lateral lines of the sidewalks on opposite sides of the highway measured from the curbs or

Glossary-2

in the absence of curbs, from the edges of the traversable roadway, and in the absence of a sidewalk on one side of the roadway, the part of a roadway included within the extension of the lateral lines of the sidewalk at right angles to the centerline; (b) any portion of a roadway at an intersection or elsewhere distinctly indicated for pedestrian crossing by lines or other markings on the surface. (MUTCD)

**CYCLE LENGTH:** The time required for one complete sequence of signal indications. (MUTCD)

**DEAD-END STREET:** A local access system street opened at one end only with special provisions for a vehicle to turn around.

**DESIGN SPEED:** Usually up to five miles per hour above the expected operating speed of the facility under design.

**DETECTABLE WARNING:** A standardized surface feature built in or applied to walking surfaces or other elements to warn visually impaired people of hazards on a circulation path.

**DETECTOR:** A sensing device used for determining the presence or passage of vehicles or pedestrians. (MUTCD)

**DEVELOPER:** A site planner or subdivider.

**DEVELOPMENT OR DEVELOPMENT PLAN:** Any site plan or subdivision.

**DRIVEWAY ACCESS POINT:** A point of ingress and egress, or both, which is considered a private driveway. It can be either a residential access point or a commercial driveway access point.

**DRIVEWAY WIDTH:** The narrowest width of driveway measured parallel with the edge of street.

**EXTENDED BUTTON PRESS:** On APS, holding the ped button down between 1-3 sec. may activate special features, including audible beaconing and extended pedestrian clearance interval.

**FHWA:** Federal Highway Administration

**FIXED TIME OPERATION:** See Pretimed operation.

**FLASHING (FLASHING MODE):** A mode of operation in which a traffic signal indication is turned on and off repetitively. (MUTCD)

**FLOW LINE:** The transition point between the gutter and the face of the curb. For a valley curb it is the center of the pan. Where no curb exists, the flow line will be considered the edge of the traveled way.

**FULL-ACTUATED OPERATION:** A type of traffic control signal operation in which all signal phases function on the basis of actuation. (MUTCD)

**GRADING PERMIT:** Permit issued by the City of Franklin Engineering Department that allows the contractor to begin grading work.

HBP: Hot bituminous pavement

INTERSECTION: (a) the area embraced within the prolongation or connection of the lateral curb lines, or if none, the lateral boundary lines of the roadways of two highways that join one another at, or approximately at, right angles, or the area within which vehicles traveling on different highways that join at any other angle may come into conflict; (b) the junction of an alley or driveway with a roadway or highway shall not constitute an intersection. (MUTCD)

INTERVAL SEQUENCE: The order of appearance of signal indications during successive intervals of a signal cycle. (MUTCD)

INTERVAL: The part of a signal cycle during which signal indications do not change. (MUTCD)

ITE: Institute of Traffic Engineers

LEVEL OF SERVICE: A measurement of the quality of service on transportation infrastructure. This is generally links to transportation trip time as it relates to speed.

LOCATOR SIGNAL: See Pushbutton locator tone.

LONG BUTTON PRESS: SEE EXTENDED BUTTON PRESS.

LONG CANE: A cane individually prescribed to provide safety and orientation information to persons who are blind or visually impaired; typically much longer than a support cane and not intended for support; typically has a white, reflective surface.

LOOP STREET: A street which is designed to discourage through traffic from other areas and both ends of the loop street connect with the same intersecting street.

MAJOR STREET: The street normally carrying the higher volume of vehicular traffic. (MUTCD)

MAJOR THOROUGHFARE PLAN: Plan in initiated by the City of Franklin Planning Department to address some design features as they relate to thoroughfares.

MEDIAN: That portion of a divided roadway separating the traveled ways for traffic in opposite directions.

MEWS: A special type of alley that serves as the only vehicular and emergency access for lots abutting the mews.

MINOR STREET: the street normally carrying the lower volume of vehicular traffic. (MUTCD)

NCHRP: National Cooperative Highway Research Program

PASSIVE PEDESTRIAN DETECTION: A feature that uses sensors (piezo-electric, infrared, microwave, or video camera serving remote sensor software) to trigger, cancel, or lengthen pedestrian timing, or to trigger the pushbutton locator tone when the pedestrian enters the detection zone.



**PAVEMENT MARKINGS:** All lines, words or symbols, except signs officially placed within the roadway or parking area to regulate, warn or guide traffic.

**PCC:** Portland cement concrete

**PEAK-HOUR VOLUME:** Hourly traffic volume used for roadway design and capacity analysis, usually occurring during one or more peak travel hours during a 24 hour period.

**PEDESTRIAN CHANGE INTERVAL:** An interval during which the flashing UPRAISED HAND (symbolizing DONT WALK) signal indication is displayed. When a verbal message is provided at an accessible pedestrian signal, the verbal message is "wait." (MUTCD)

**PEDESTRIAN PHASE (OR PED PHASE):** The cycle of pedestrian timing consisting of three parts: (1) The walk interval (WALK sign); (2) the pedestrian clearance interval (flashing DON'T WALK); and the pedestrian change interval (steady DON'T WALK).

**PEDESTRIAN SIGNAL HEAD:** A signal head, which contains the symbols WALKING PERSON (symbolizing WALK) and UPRAISED HAND (symbolizing DON'T WALK), that is installed to direct pedestrian traffic at a traffic control signal. (MUTCD).

**PEDESTRIAN:** People who travel on foot or who use assistive devices, such as wheelchairs, for mobility.

**PERMISSIVE MODE.:** A mode of traffic control signal operation in which, when a CIRCULAR GREEN signal indication is displayed, left or right turns may be made after yielding to pedestrians and/or oncoming traffic. (MUTCD)

**PLANNING COMMISSION:** Appointed board of local citizens responsible for decision making related to growth and development within the City.

**PREEMPTION CONTROL:** The transfer of normal operation of a traffic control signal to a special control mode of operation. (MUTCD)

**PRETIMED OPERATION:** Type of traffic control signal operation in which none of the signal phases function on the basis of actuation. (MUTCD)

**PRIORITY CONTROL:** A means by which the assignment of right-of-way is obtained or modified. (MUTCD)

**PROTECTED MODE:** A mode of traffic control signal operation in which left or right turns may be made when a left or right GREEN ARROW signal indication is displayed. (MUTCD)

**PROWAAC:** Public Rights of Way Access Advisory Committee of the U.S. Access Board, that includes advocates, engineers, architects, and public works officials.

**PUDE:** Public utility and drainage easement

**PUSHBUTTON LOCATOR TONE:** A repeating sound that informs approaching pedestrians that they are required to push a button to actuate pedestrian timing and that enables pedestrians who have visual disabilities to locate the pushbutton. (MUTCD)

**PUSHBUTTON MESSAGE:** A speech message that provides additional information when the APS pedestrian pushbutton is pushed.

**PUSHBUTTON:** A button to activate pedestrian timing. (MUTCD)

**REMOTE ACTIVATION:** A handheld pushbutton device allowing a pedestrian to send a message over a short distance to call the ped phase.

**RESIDENTIAL DRIVEWAY ACCESS:** A driveway access point serving a single family dwelling, mobile home, detached townhouse, two attached townhouses, duplex, multi-unit supportive housing residence, supportive housing residence which is required to provide no more than two (2) off-street parking spaces, or a driveway serving a nonresidential use if the daily volume of two-way driveway traffic is expected to be less than fifty (50) vehicles.

**RIGHT-OF-WAY CENTER LINE:** (1) The right-of-way centerline of a two-way street shall be a point equidistant between the inside edges of the innermost through travel lane in each direction of travel. (2) The right-of-way centerline of a one-way street shall be a point equidistant between the outside edges of the outermost through travel lanes in the direction of travel. (3) Where the alignment of an existing street is to be altered or changed, the right-of-way centerline shall be determined in accordance with the new realignment plan, provided the City and/or TDOT have approved the plan. (4) In special cases where non-symmetrical street widening has occurred or other unique situations not covered by the above exist, the right-of-way centerline shall be defined by the Transportation Director.

**RIGHT-OF-WAY, (ROW) :** An interest in land to the City which provides for the perpetual right and privilege of the City and its agents, franchise holders, successors, and assigns to construct, install, improve, repair, maintain, and use a public street, including related and customary uses of street rights-of-way such as sidewalk, bike path, landscaping, traffic control devices and signage, sanitary sewer, stormwater drainage devices, water supply, cable television, electric power, gas, and telephone transmission and related purposes in, upon, over, below, and across the right-of-way. The City is authorized to remove, and keep removed from the rights-of-way all trees, vegetation, and other obstructions as is determined to be necessary by the City to maintain, repair, and protect facilities located in the right-of-way

**ROADWAY:** See definition of street.

**SEMIACTUATED OPERATION:** A type of traffic control signal operation in which at least one, but not all, signal phases function on the basis of actuation. (MUTCD)

**SIDEWALK:** Any public or private pedestrian or bicycle walkway or path.

**SIGNAL HEAD.** An assembly of one or more signal faces together with the associated signal housings. (MUTCD)

**SIGNAL INDICATION:** The illumination of a signal lens or equivalent device. (MUTCD)

**SIGNAL PHASE:** The right-of-way, yellow change, and red clearance intervals in a cycle that are assigned to an independent traffic movement or combination of movements. (MUTCD)

**SIGNAL SECTION:** The assembly of a signal housing, signal lens, and light source with necessary components to be used for providing one signal indication. (MUTCD)

**SIGNAL TIMING:** The amount of time allocated for the display of a signal indication. (MUTCD)

**SIGNAL WARRANT:** A threshold condition that, if found to be satisfied as part of an engineering study, shall result in analysis of other traffic conditions or factors to determine whether a traffic control signal or other Improvement is justified. (MUTCD)

**SLOPE EASEMENT:** An easement, which is reasonably necessary and incidental to the construction within the adjoining right-of-way of public street or sidewalk, or both, by the City, state, or their contractors. The purposes to which the easement area may be used include cutting, sloping, filling, installation of stormwater drain pipes or other drainage facilities, grading or otherwise changing the natural contour of the easement area in order to support and to accommodate the development of the adjacent street right-of-way, in accord with generally accepted engineering practices. Following the construction of the adjacent street or sidewalk, or both, the area subject to this easement will be graded, stabilized, and restored using conventional engineering and landscaping methods. Thereafter, the landowners with the underlying fee interest may make and enjoy all lawful uses of the property subject to this easement, provided there be no damage to the lateral and subjacent support of the public street, sidewalk, or h or to any stormwater drainage facility.

**STATE ROUTE:** An arterial highway designated and signed with a route number, which is primarily funded for construction and administered by TDOT. Improvements and maintenance of state routes is under the jurisdiction of TDOT.

**STEADY (STEADY MODE):** The continuous illumination of a signal indication for the duration of an interval, signal phase, or consecutive signal phases. (MUTCD)

**STORMWATER ORDINANCE:** Document initiated by the City of Franklin to establish guidelines for dealing with stormwater.

**STORMWATER PERMIT:** If approaches to handling stormwater are not standard or specified in the stormwater ordinance, a stormwater permit may need to be applied for by the contractor.

**STREET BLOCK FACE:** The physical characteristics of property and structures adjoining any one side of a street in-between intersections.

**STREET SCAPE:** Aesthetic additions (trees, decorative lighting) that are placed outside of the traveled way to enhance appearance.

**STREET:** A public or private roadway, but is not considered a driveway access point.

**STREET DEPARTMENT DIRECTOR:** City official responsible for directing and overseeing construction, maintenance, traffic control and stormwater implementation for improvements of City streets.

**SUBDIVISION REGULATIONS:** Documents initiated by the City of Franklin to establish guidelines for subdivision plans.

**TACTILE ARROW (ALIGNED IN DIRECTION OF TRAVEL):** A raised (tactile) arrow in an APS pushbutton that helps users know which crosswalk is actuated by the pushbutton.

**TACTILE MAP:** A raised schematic map (located on an APS pushbutton housing) that shows what will be encountered as the pedestrian negotiates the crosswalk controlled by that push button.

**TACTILE:** An object that can be perceived using the sense of touch.

**TDEC:** Tennessee Department of Environment and Conservation

**TDOT:** The Tennessee Department of Transportation

**THROUGH STREET:** A street, other than a dead-end street or loop street, that connects two perimeter property lines of a development.

**TIA:** Traffic impact analysis

**TN DIVISION OF WATER POLLUTION CONTROL:** A regulatory board that monitors pollution.

**TRAFFIC CONTROL SIGNAL (TRAFFIC SIGNAL):** Any highway traffic signal by which traffic is alternately directed to stop and permitted to proceed. (MUTCD)

**TRAFFIC SIGN:** A device mounted on a fixed or movable support, conveying a message or symbol to regulate, warn or guide traffic.

**TRANSPORTATION ADVISORY COMMITTEE:** Committee that reviews transportation related items and makes recommendations to BOMA.

**TREE REMOVAL PERMIT:** Permit issued by the City of Franklin Codes Department that allows the contractor to clear designated trees.

**VIBROTACTILE PEDESTRIAN DEVICE:** A device that communicates, by touch, information about pedestrian timing using a vibrating surface. (MUTCD)

**VOLUME:** The number of vehicles passing a given point during a specified period of time.

**WALK INTERVAL:** An interval during which the WALKING PERSON (symbolizing WALK) signal indication is displayed. When a verbal message is provided at an accessible pedestrian signal, the verbal message is "walk sign." (MUTCD)

**ZONING ORDINANCE:** Document that regulates land use for the City of Franklin.